



MNPVHV Disco Installation Instructions



MNPV8HV TYPE 4X



MNPV8HV TYPE 3R

The MNPVHV combiners are rated for outdoor use. Designed for combining high voltage strings using 10mm x 38mm fuses. The use of touch safe din rail mount fuse holders and fuses allow operation up to 600 Volts.

This Manual covers the following models:

- MNPV4HV TYPE 3R
- MNPV6HV TYPE 4X
- MNPV8HV TYPE 4X
- MNPV8HV TYPE 3R
- MNPV16HV TYPE 4X

Applications:

- Disconnecting combiner

Features:

- Outdoor enclosures available in Type 3R and Type 4X
- Powder coated aluminum construction stands up to the elements
- Type 4X units are waterproof to two Meters depth in any orientation
- Combiners are designed for use with one or two inverters or one non-isolated inverter
- “Convertible” design allows for great flexibility
- Big Red Handle makes for easy to understand operation
- Clear Deadfront provides safety and a look inside
- Additional remote disconnects can be added – any remote can turn off all combiners
- Compatible with the Birdhouse for remote disconnect and other features (sold separately)
- Meets and exceeds NEC 2011 requirements

IMPORTANT SAFETY INSTRUCTIONS

SAVE THESE INSTRUCTIONS - These instructions contain important safety and operating instructions for the MidNite Solar MNPVHV solar combiner boxes and MNDC156-600 Disconnect Switch.

If you do not fully understand any of the concepts, terminology, or hazards outlined in these instructions, please refer installation to a qualified dealer, electrician or installer. These instructions are not meant to be a complete explanation of a renewable energy system.

GENERAL PRECAUTIONS

If service or repair should become necessary, contact MidNite Solar Inc. Improper servicing may result in a risk of shock, fire or explosion. To reduce these risks, disconnect all wiring before attempting any maintenance or cleaning. Turning off the inverter will not reduce these risks. Solar modules produce power when exposed to light. When it is not possible to disconnect the power coming from the Photovoltaics by an external means such as a combiner, cover the modules with an opaque material before servicing any connected equipment.

Do not work alone. Someone should be in the range of your voice or close enough to come to your aid when you work with or near electrical equipment.

Remove rings, bracelets, necklaces, watches etc. when working with photovoltaic modules or other electrical equipment. Power from an illuminated photovoltaic array makes a very effective arc welder with dire consequences if one of the welded pieces is on your person.

Table of contents.

Introduction	-----3
Installation	-----3
Wire torque requirements	-----4
Reconfiguring combiners	-----6
MNSPD	-----17
Wiring	-----19
Optional Accessories	-----23
Warranty	-----30
Contact information	-----30

Disclaimer

Unless specifically agreed to in writing, MidNite Solar Inc.

(a) Makes no warranty as to the accuracy, sufficiency or suitability of any technical or other information provided in its manuals or other documentation.

(b) Assumes no responsibility or liability for loss or damage whether direct, indirect, consequential or incidental, which might arise out of use of such information. The use of any such information will be entirely at the user's risk.

MNPVHV Disco Installation Instructions (continued)

Introduction

The MNPVHV series of combiners are designed for indoor / outdoor use. Type 4X have been tested to be watertight to 2 meters underwater, so they are sure to be watertight above sea level. The MNPV4HV and MNPV6HV are basic disconnecting combiners while the MNPV8HV and MNPV16HV are reconfigurable to accommodate Non-Isolated inverters or to divide one combiner into two separate halves to power 2 inverters.

Overview of size/ratings:

MNPVHV4 TYPE 3R	4 position, 80A, NEMA 3R
MNPVHV6 TYPE 4X	6 position, 100A, NEMA 4X
MNPVHV8 TYPE 3R	8 position, 100/200A, NEMA 3R or 4X, configurable as 4 plus and 4 minus positions for non-isolated inverters
MNPVHV8 TYPE 4X	
MNPVHV16 TYPE 4X	16 position, 200A, NEMA 4X, configurable as 8 plus and 8 minus position for non-isolated inverters

Installation

To remove the deadfront:

Note: The plastic dead front fits very tight. You must first remove the lid in order to remove the deadfront.

On MNPV4HV units, pry off the lid as shown using something like a screwdriver as a lever. The dead front then lifts out easily.

On TYPE 4X units the deadfront is secured to the busbars just above the fuseholders. To remove it, gently lift it out from the top.

To reinstall the deadfront on all units, press it gently into place. There will be a gentle snap when it seats.



Remove top cover prior to removing the deadfront on Type 3R units.

The installation of a PV combiner is fairly straight forward. Select the location to install your combiner first. Some systems have the PV modules located close to the inverters. If this is the case, you can elect to mount the MNPV inside and run each PV string down to the MNPV inside the building. This is convenient for trouble shooting and upgrading. For longer runs the combiner will be mounted outdoors on the pole for pole mounted PV arrays or similar mounting for rack mounted arrays. Combiners with a TYPE 3R enclosure can be mounted in the vertical position or slanted backwards to accommodate up to a 12/12 roof pitch. All unused holes should be blocked using RTV sealant or something similar in order to keep rain and insects out of the enclosure. Care must be taken to insure that no water will get on terminal busbars or fuse holders when mounted less than vertical. Type 4X units are submersible to two meters in any orientation, so it will certainly be watertight above sea level. Be sure to comply with all local and national code requirements including National Electrical Code Code, ANSI/NFPA 70. Combiners should be mounted with #10 or larger stainless steel hardware.

There are various wiring diagrams and system examples available at www.midnitesolar.com click on Documents at the top of the page for links to wiring diagrams in PDF as well as links to AutoCad wiring diagrams and even solid models aimed at aiding the system installer and designer. As such we request that they not be used for any other purpose.

Caution! Do not disconnect any cables under load. Remove power prior to connecting or disconnecting any cable connections. If necessary, cover the solar panels with opaque material to remove power. Extremely bad things *Will* happen if connections are opened under load.

MNPVHV Disco Installation Instructions (continued)

Torque –Fuseholder	
USM1 Fuse holder	15 in-lbs (1.7Nm)

Torque – Terminal Bus Bar	
10AWG	20 in-lbs (2.3Nm)
8AWG	25 in-lbs (2.8Nm)
6AWG	35 in-lbs (4.0Nm)
4AWG	45 in-lbs (5.1Nm)
2AWG – 1/0	50 in-lbs (5.6Nm)

Recommended torque values.
 These values apply to all the bus bars and the Plus output box lug up to 2/0.
 Re-torque fuse holders after one hour.

The MidNite MNPVHV combiners utilize touch safe fuse holders and fuses rated for up to 600 volts DC. The MNPV8HV can accommodate eight USM1 type fuse holders made by Ferraz Shawmut or other compatible fuse holders. Fuses are available from 1 to, 30 amps. (The combiners come with 15 amp fuses installed except special built).

Do not open the fuseholders under load.
 You **WILL** have a fire on your hands!



Ferraz Shawmut
 USM1 Touch Safe fuseholder
 Midnite Solar part number - MNTS



Enclosure Notes:

In order to ensure water-tightness on Type 4X units and rain-tightness on the Type 3R units it is important to install connectors or hole plugs into every opening. Silicone sealant can be used to plug all openings on Type 3R units except for the two 1/8" drain holes.

On Type 4X units two 1/8" drain holes can be placed at the lowest point on the enclosure. The enclosure will not be as water-tight, but this will give any condensation that may build up a way out of the enclosure.



MNPV16HV Type 4X bottom Shown with plugs

Tighten firmly with tool available from MidNite Solar

MNPVHV Disco Installation Instructions (continued)

Enclosure Notes Continued:

Tighten hole plugs firmly on 4X units with MidNite Solar tool part number 5-151-1 (included). Tighten from the inside of the combiner to avoid twisting the gasket.

Tighten from the inside of the combiner

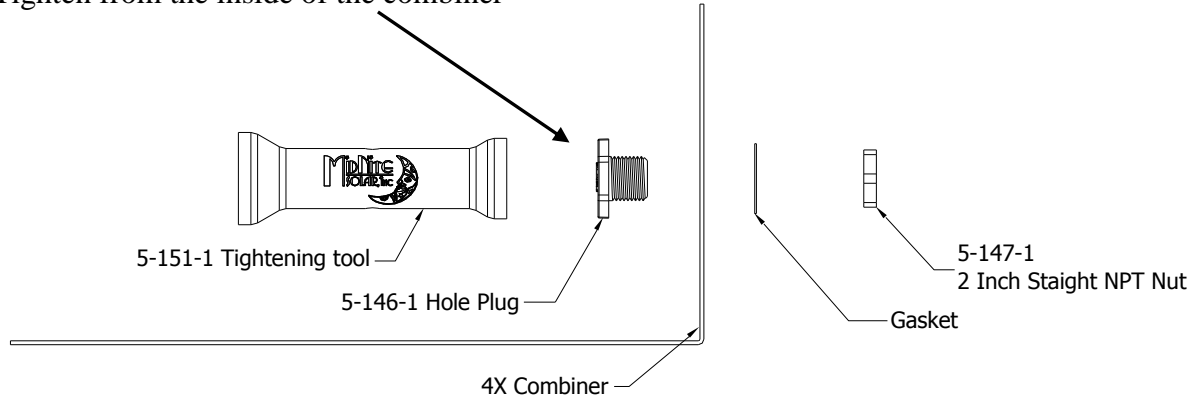

Hole plug parts placement

Installing adapter fittings:

When using reducing adapters, install the adapter and gasket through the front and the nut from inside the combiner. Tighten firmly from the inside of the combiner with tool supplied.



Reducing adapters shown installed

MNPVHV Disco Installation Instructions (continued)

Reconfiguring MNPVHV Combiners:

MNPVHV Combiners come complete with all the busbars and additional labels required to reconfigure to any of the three configurations, Non-Isolated, 2 Inverter and Parallel. All combiners are shipped from the factory setup as parallel.

You will need:

#2 Phillips screwdriver

Slotted screwdriver

5/16, 3/8 and 7/16 wrenches

Crimper for MNSPD ring lugs

First, the definition of the configurations.

1. **Parallel:** In this mode the Negative input busbars are joined into a single unit and the Positive outputs are joined at the disconnect providing a 16 string combiner. This is the default configuration.
2. **2 Inverters:** In this mode the Negative input busbars are separate as are the Positive outputs providing 2 separate 8 string combiners with a single 2 pole disconnect.
3. **Non-Isolated:** In this mode the negative input busbars are not used, rather the Negative inputs go directly to the 8 fuseholders on the left and the Positive inputs go to the 8 fuseholders on the right. This provides an 8 string combiner on the Negative as well as on the positive with a single 2 pole disconnect as required for a Non-Isolated installation.

MNPV16HV:



MNPV16HV Parallel configuration (default).
16 string Disconnecting Combiner

MNPVHV Disco Installation Instructions (continued)

Reconfiguring MNPVHV Combiners continued: MNPV16HV

The following instructions assume starting from the default (parallel) configuration. If starting from another setup then either revert to the default (Parallel) configuration or follow the instructions for the desired configuration bearing in mind that the instructions may ask you to add/remove a busbar or label that has already been added/removed. If reverting back to parallel follow the instructions for the current configuration in reverse.

Components supplied for reconfiguring MNPV16HV:

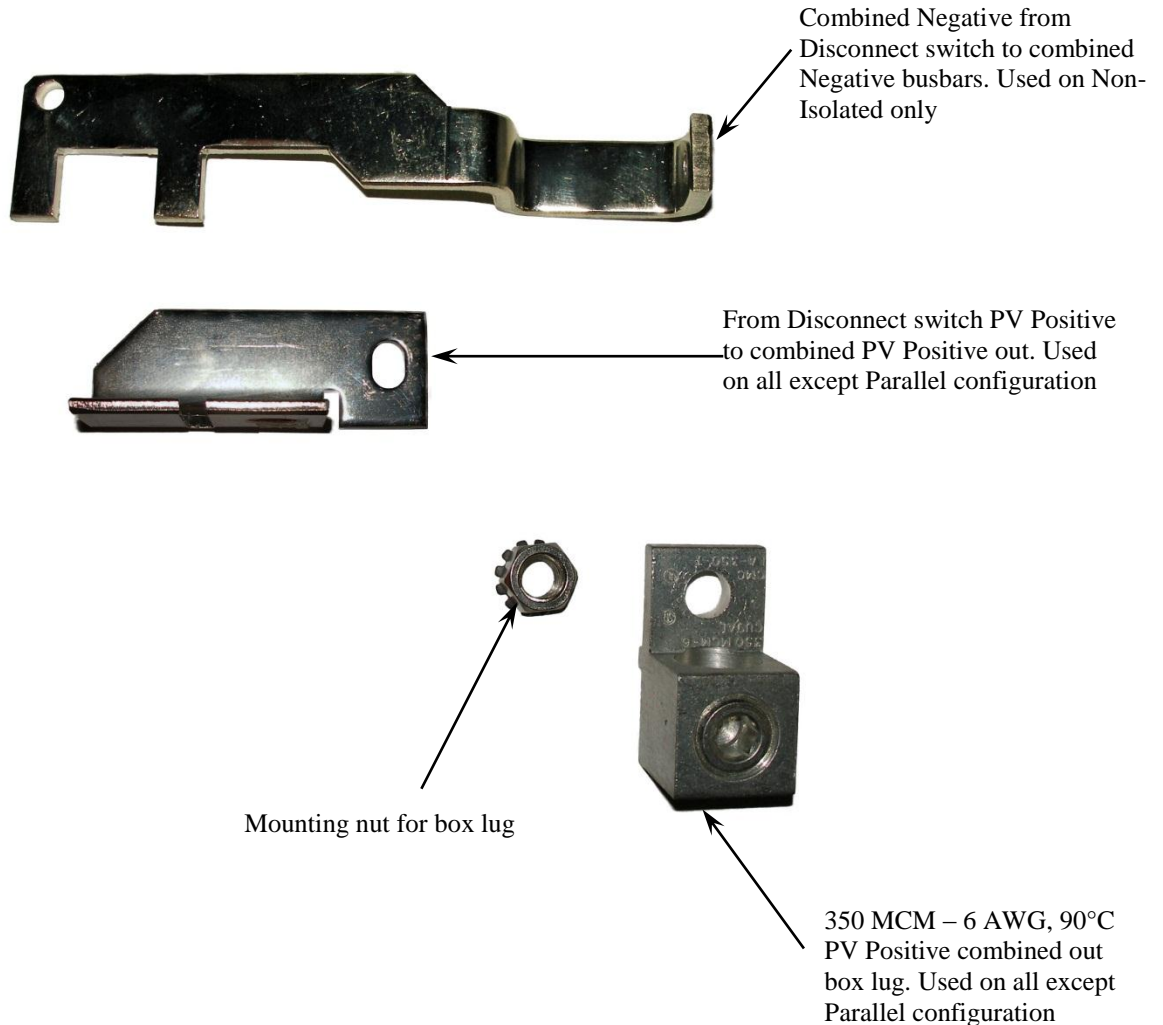

The parts above (included) are all that is required to convert the MNPV16HV Combiner to any of its configurations.

On TYPE 4X units a special sealing screw is used to ensure that the unit is water-tight. Use of other screw types will compromise the seal and should not be used.



MNPVHV Disco Installation Instructions (continued)

Reconfiguring MNPVHV Combiners continued: MNPV16HV

Parallel to 2 Inverters: Starting with a parallel configured MNPV16HV.
The MNPV16HV TYPE 4X is shown.

Step 1: Remove PV Negative block

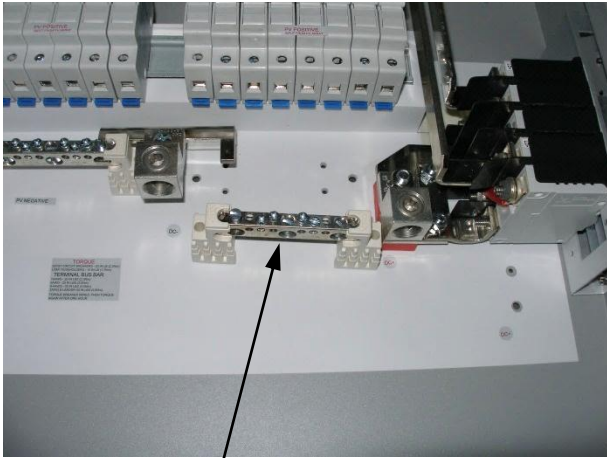

Remove terminal block by removing screws (2) from bottom. This is to provide access for Step 2

Step 3: Remove small busbar from PV Positive Combined Out lug

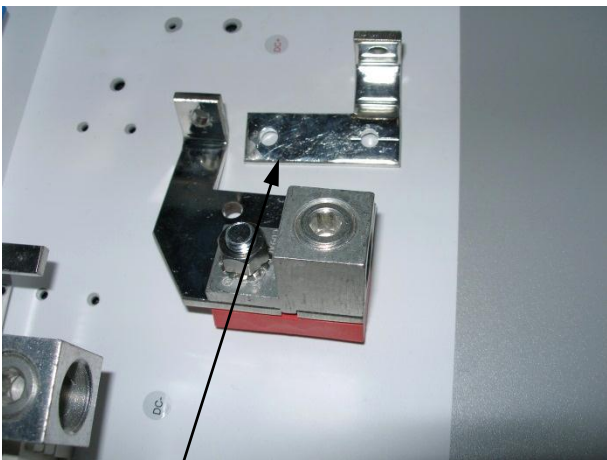

Remove PV Positive output lug from switch.
Remove small busbar from PV Positive lug

Step 2: Remove PV Positive Combined Out and Negative box lugs

Remove PV Negative Output lug and set aside. It is not used in the 2 Inverter configuration.

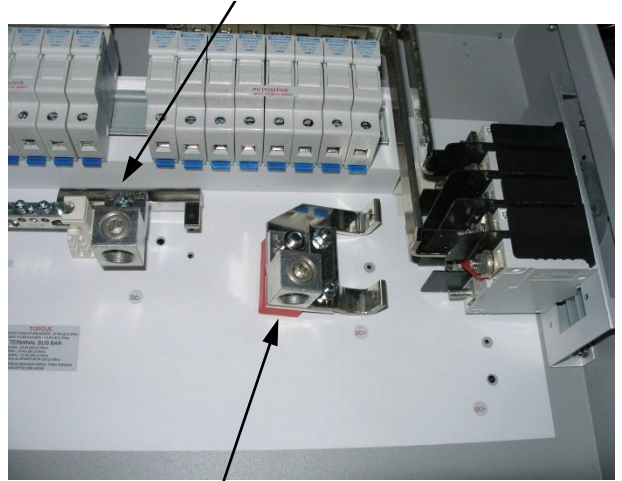

Remove PV Positive Combined Out lug by removing nuts on breakers. It will be reinstalled in Step 4

Step 4: Reinstall PV Positive box lug

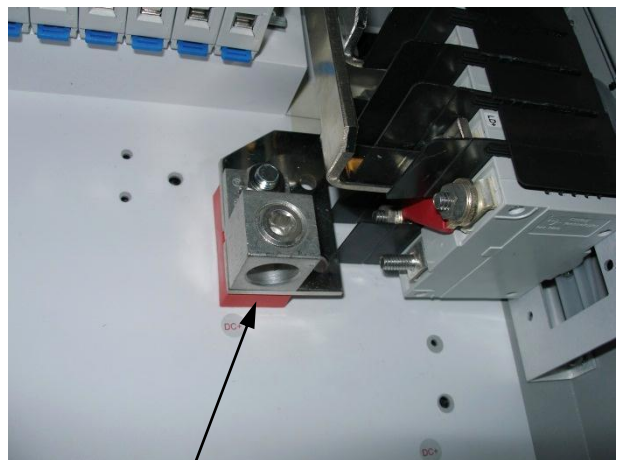

Reinstall PV Positive Output box lug in its original position using a 7/16" boxwrench. See torque chart on page 4. Install sealed 10-32 X 3/8 screw through bottom into red insulator brass insert

MNPVHV Disco Installation Instructions (continued)

Reconfiguring MNPVHV Combiners continued: MNPV16HV

Step 5: Install PV Positive box lug

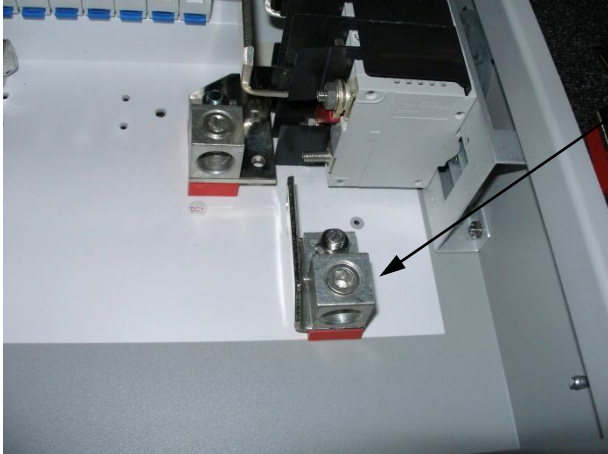

Install PV Positive Output box lug on bottom position of switch. See torque chart on page 4. Finally, replace PV Negative busbar removed in step 1 and install busbar.

Leftover parts should include the Non-Isolated Negative busbar, the PV negative lug removed in step 2 and the small busbar removed in step 3

When you have finished the conversion it would be a good idea to compare your result with the photo below to be sure that all steps were completed correctly. You should now have two separate eight string combiners in one box

MNPV16HV 2 Inverter Reconfiguration checklist

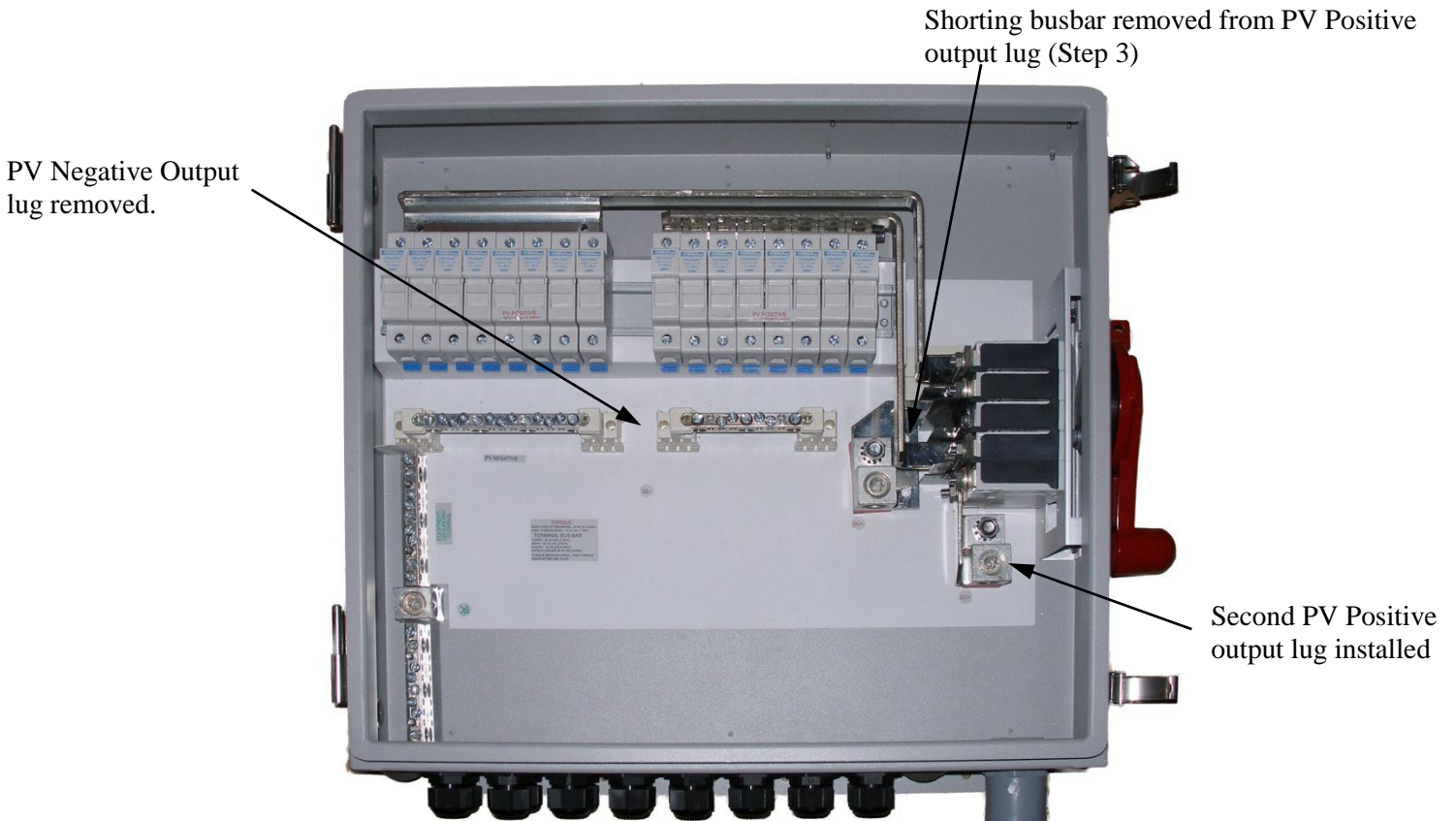

MNPVHV Disco Installation Instructions (continued)

Reconfiguring MNPVHV Combiners continued: MNPV16HV

Parallel to Non-Isolated: Starting with a parallel configured MNPV16HV.
The MNPV16HV TYPE 4X is shown.

Step 1: Remove PV Negative block

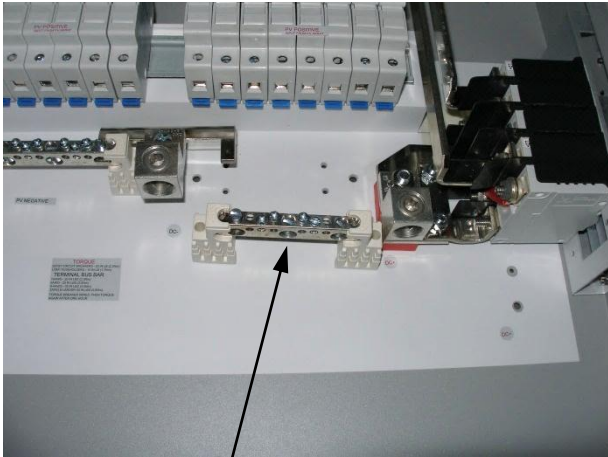

Remove terminal block by removing screws (2) from bottom. This is to provide access for Step 2

Step 2: Remove PV Positive Combined Out.

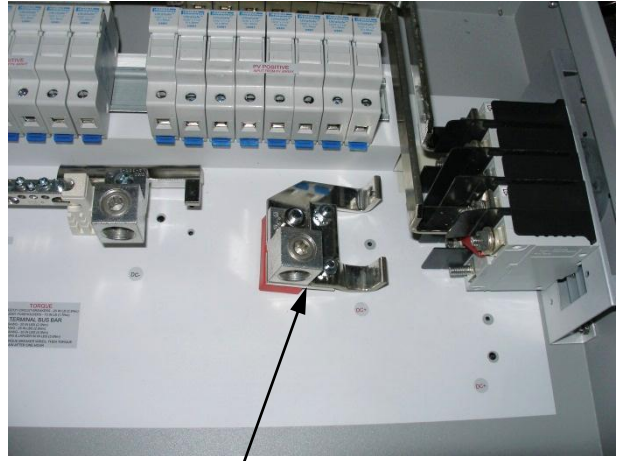

Remove PV Positive Combined Out lug by removing nuts on breakers. Set aside, the other box lug and busbar are used in this configuration

Step 3: Install PV Positive box lug

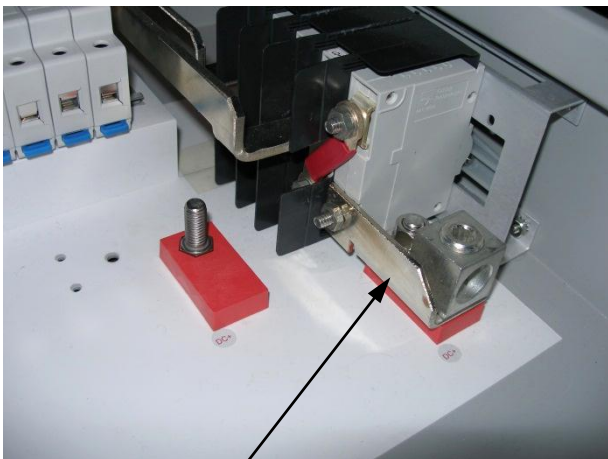

Install PV Positive Output box lug.
See torque chart on page 4

Step 4: Install combined Negative out busbar

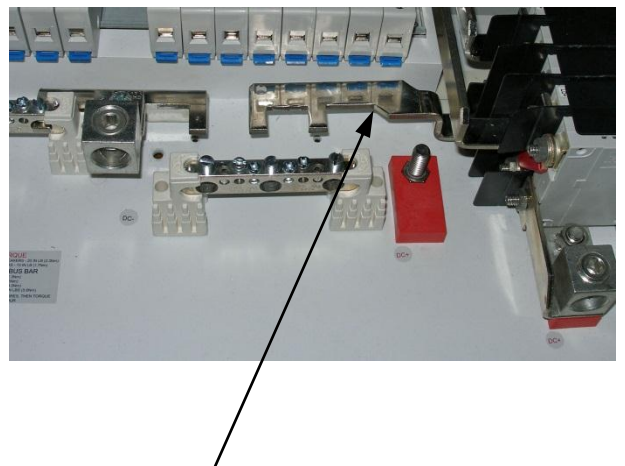

Install PV Negative out busbar. Secure to switch on the second position down from the top as shown.

MNPVHV Disco Installation Instructions (continued)

Reconfiguring MNPVHV Combiners continued: MNPV16HV

Step 5: Install PV Negative terminal block

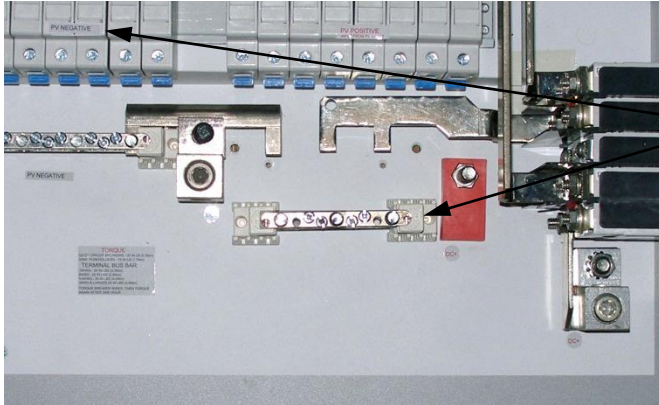

Install supports on terminal block and slide into position, secure supports with screws removed in step 1. Tighten the three electrical connections on the bar. See torque chart on page 4. Remove “PV Positive” Label from fuseholders on the Left side and replace with “PV Negative” Label.

The parts left over should be the PV Positive out box lug with small busbar removed in step 2

When you have finished the conversion it would be a good idea to compare your result with the photo below to be sure that all steps were completed correctly. You should now have a combiner ready for eight Non-Isolated inputs (Fuses on each Positive and Negative string input with disconnects on Positive and Negative combined outputs).

MNPV16HV Non-Isolated Reconfiguration checklist

PV Positive sticker changed to PV Negative

PV Negative Output busbar installed.

Shorting busbar and PV Positive lug removed

PV Positive output lug installed

PV Positive output lug removed. Plastic base remains

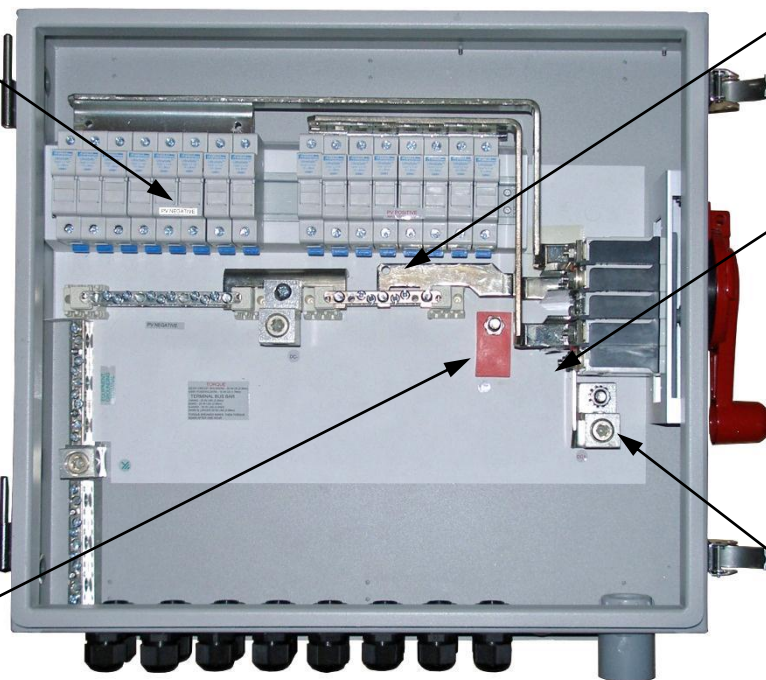

MNPV16HV Configured as Non-Isolated

MNPVHV Disco Installation Instructions (continued)

Reconfiguring MNPVHV Combiners continued: MNPV8HV

These additional busbars supplied with the MNPV8HV Combiner are all that is needed to convert it to any of its configurations

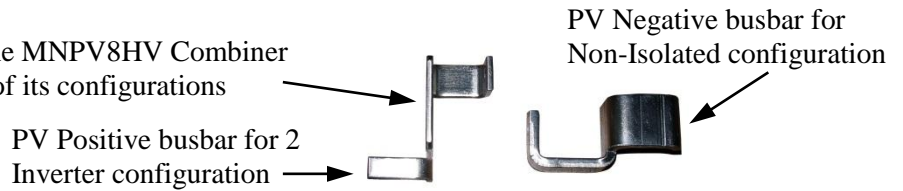

Parallel to 2 Inverters: Starting with a parallel configured MNPV8HV. The MNPV8HV TYPE 4X is shown, but the process is the same for the MNPV8HV TYPE 3R.

Step 1: Remove Output blocks and Negative jumper busbar

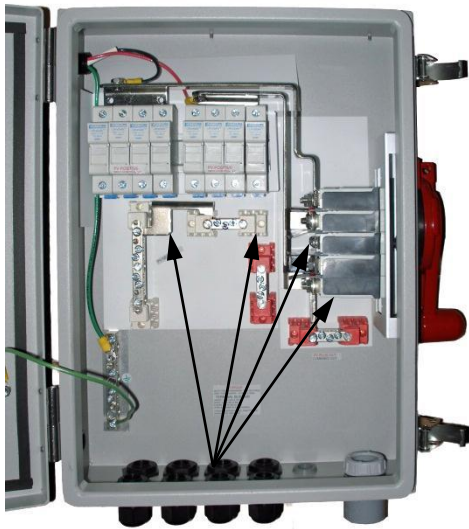

Remove Positive and Negative terminal blocks and the Negative jumper busbar as shown.

Step 2: Remove Positive Output busbar

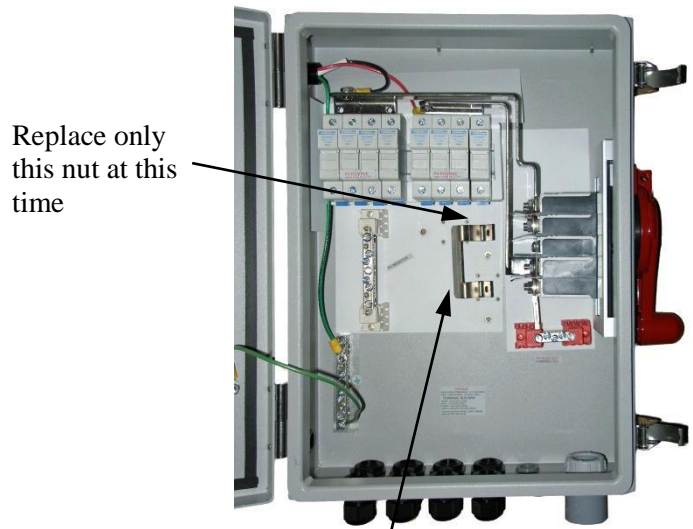

Remove Positive jumper busbar from switch, set aside, it is not used in this configuration. Replace nut on lowest position only

Step 3: Install Positive Output busbar

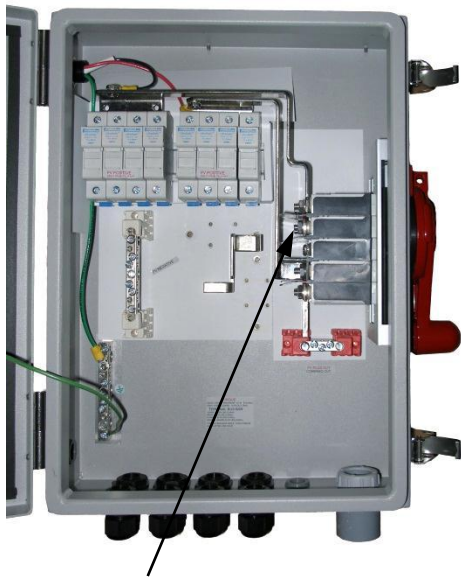

Install busbar oriented as shown.

Step 3 continued: Install Positive Output busbar

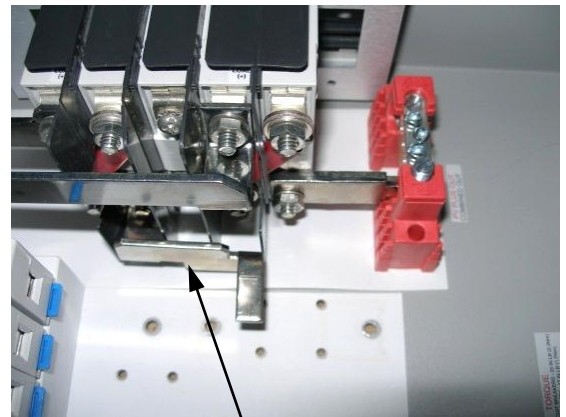

Busbar shown installed

MNPVHV Disco Installation Instructions (continued)

Reconfiguring MNPVHV Combiners continued: MNPV8HV

Step 4: Reinstall Positive block

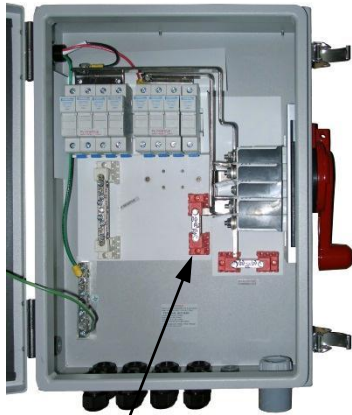

Install block. Refer to torque chart on page 4. Use screws removed in step 1

Step 5: Reinstall Negative block

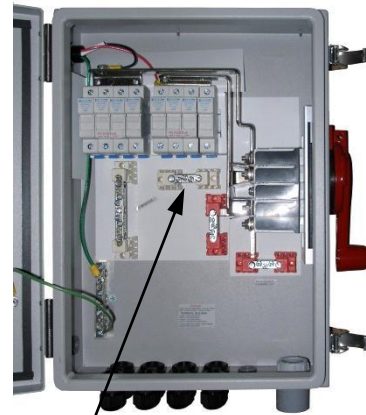

Install block. Refer to torque chart on page 4. Use screws removed in step 1

MNPV8HV 2 Inverter Reconfiguration checklist

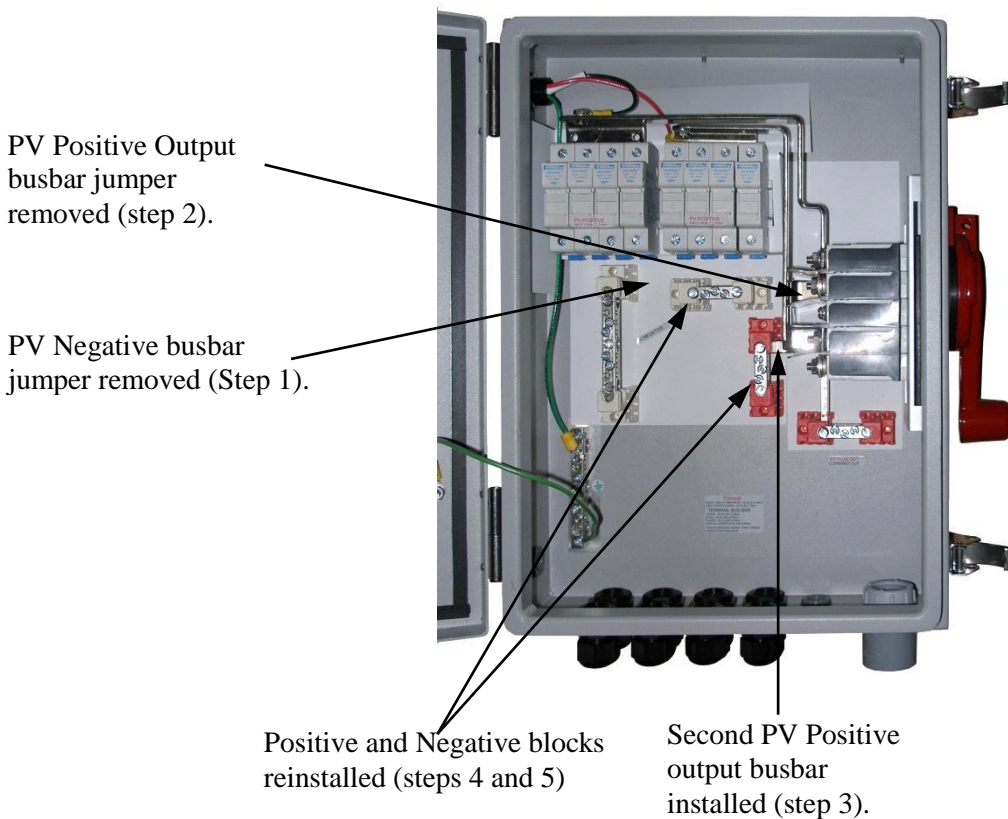

When you have finished the conversion it would be a good idea to compare your result with the photo (Left) to be sure that all steps were completed correctly. You should now have two separate four string combiners in one box. This example has one MNSPD. Refer to the wiring diagrams beginning on page 19 For adding a second MNSPD (sold separately).

Left over parts should include the PV Negative busbar jumper removed in step 1, the PV positive busbar removed in step 2, And the PV Negative Non-Isolated busbar jumper.

MNPVHV Disco Installation Instructions (continued)

Reconfiguring MNPVHV Combiners continued: MNPV8HV

Parallel to Non-Isolated: Starting with a parallel configured MNPV8HV.
The MNPV8HV TYPE 4X is shown, but the process is the same for the MNPV8HV TYPE 3R.

Step 1: Remove Output blocks and Negative jumper busbar

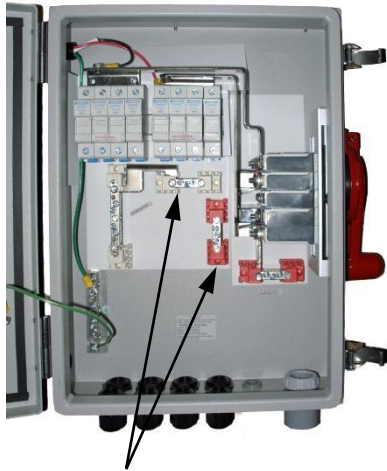

Remove Positive and Negative blocks and set aside. This is to provide access for the next steps.

Step 2: Remove Positive Output busbar

Replace only this nut at this time

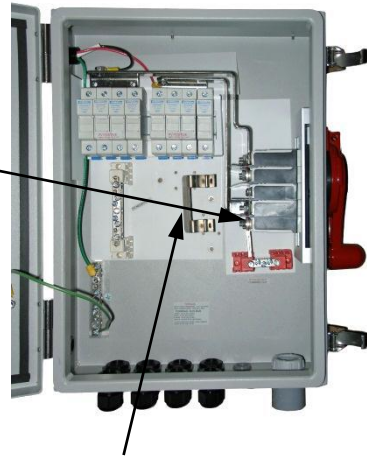

Remove Positive jumper busbar from switch, set aside, it is not used in this configuration. Replace nut on lowest position only

Step 3: Install Negative Output busbar

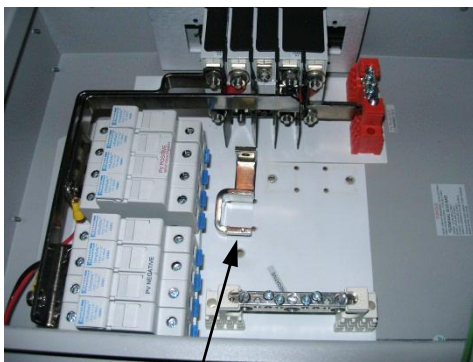

Install busbar on switch as shown.

Step 3 Continued: Install Negative Output busbar

Replace PV Positive sticker with PV Negative sticker. This location only



Busbar shown installed

MNPVHV Disco Installation Instructions (continued)

Reconfiguring MNPVHV Combiners continued: MNPV8HV

Step 4: Reinstall Negative block

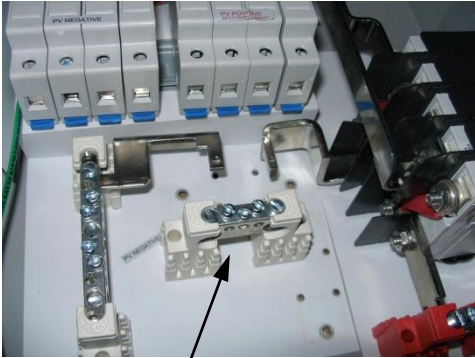

Install Negative out block with screws removed in step 1. Tighten onto busbars. Refer to torque chart on page 4.

Step 5: Reinstall block

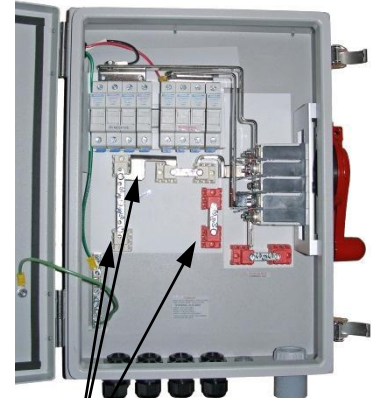

These terminal blocks are not used in this configuration. If desired you may remove them and use elsewhere, otherwise you may leave them installed here. Be sure to seal any holes left open.

Install PV Negative Output busbar (step 3).
PV Positive label changed to PV Negative label (step 3).
PV Positive Output busbar jumper removed (step 2).
PV Positive terminal block / Negative block and busbar – are not used in this configuration. They are installed here to maintain watertightness. they may be removed if the mounting holes are sealed.

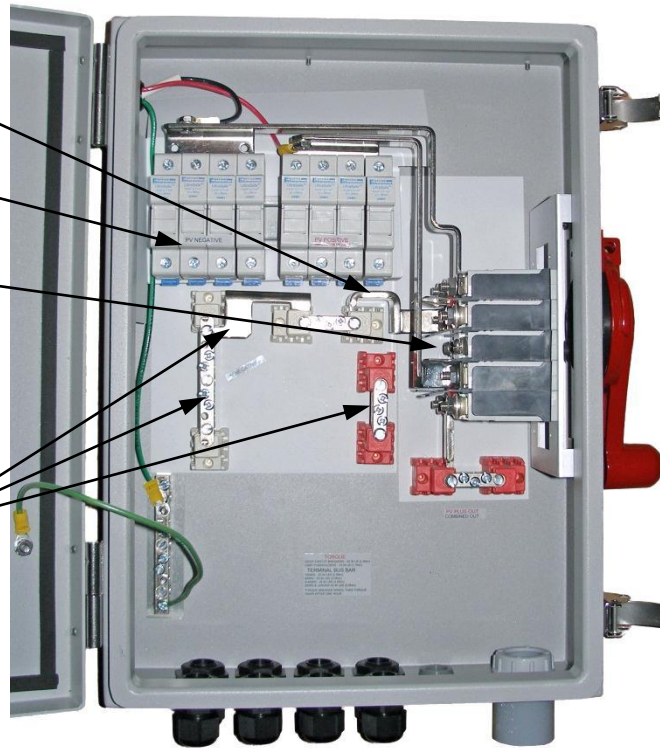

When you have finished the conversion it would be a good idea to compare your result with the photo (Left) to be sure that all steps were completed correctly. You should now have a combiner ready for four Non-Isolated inputs (Fuses on each Positive and Negative string input with disconnects on Positive and Negative combined outputs).

Leftover parts should include the PV Positive output busbar jumper removed in step 2, the PV Negative output busbar removed in step 3,

MNPVHV Disco Installation Instructions (continued)

MNPV4HV and MNPV6HV Combiners

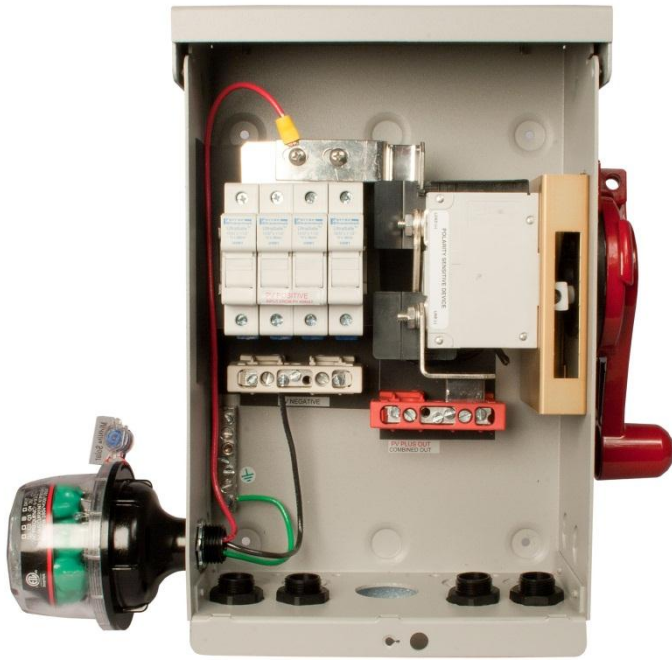

MNPV4HV TYPE 3R Deluxe

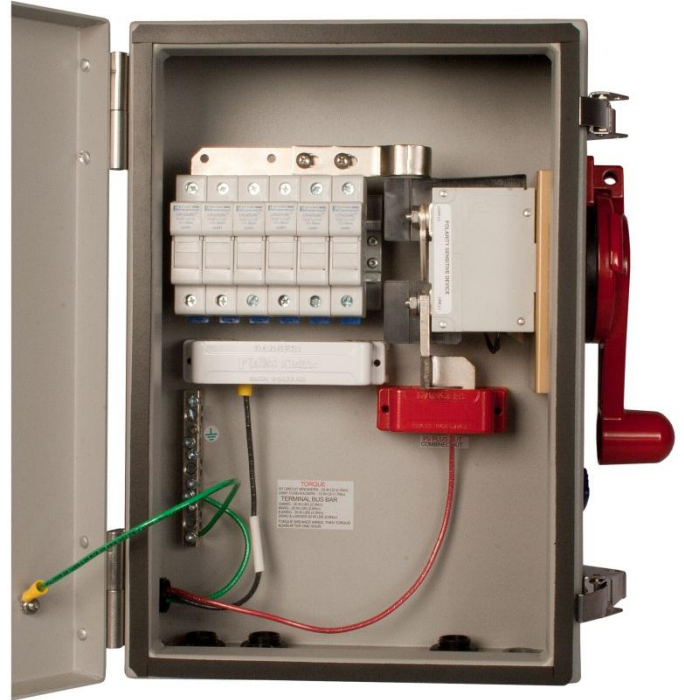

MNPV6HV TYPE 4X

MNPV4HV TYPE 3R Basic, MNPV4HV TYPE 3R Deluxe and MNPV6HV TYPE 4X Combiners are shipped configured as 4 or 6 string combiners and are not field reconfigurable.

MNPV4HV Disco 3R - Basic Disconnecting Combiner has 80 amp busbars, 100 amp switch and has two poles in series to make a 600V switch. Refer to MNPV6HV wiring diagram on page 22.

MNPV4HV Disco 3R - Deluxe Disconnecting Combiner has 80 amp busbars, 100 amp switch with a third pole which is the feedback micro switch for the birdhouse system shutdown. It also includes one MNSPD600. Refer to MNPV6HV wiring diagram on page 22.

MNPV6HV Disco 4X PV Disconnecting Combiner, 3 poles, 125 amp busbars, 100 amp switch with feedback for the birdhouse and accepts the optional power supply.

MNPVHV Disco Installation Instructions (continued)

Installing MNSPD:

The MNPVHV Combiner comes with 1 MNSPD to protect against surges. A second MNSPD (sold separately) can be added to protect 2 inverter configurations. Refer to the wiring diagrams starting on page 19.



MNSPD Surge Protector Device

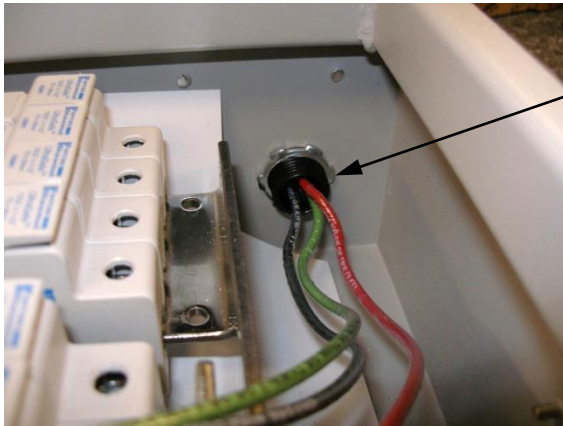

Remove the hole plug from the side of the combiner. Remove the nut from the MNSPD. Pull the wires through the side of the combiner and secure with the supplied nut. Insure that the silicone washer is installed on the outside of the chassis to maintain watertightness.

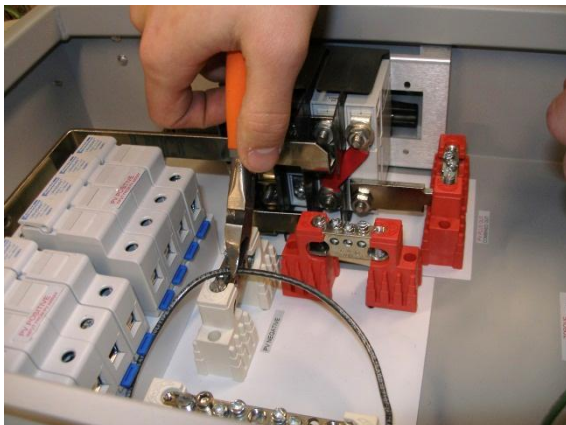

The wiring varies based on which configuration is used, so the wires will need to be cut to length. Refer to the wiring diagrams beginning on page 19 for details on your configuration

In this example (2 Inverters) the Black wire is run to the Negative and cut to length, stripped and secured in in the Negative busbar. Add a length of white heatshrink to the end of this wire to signify the grounded conductor. The red connects to the combined PV Plus busbar, the green wire goes to the ground terminal block. The second MNSPD (sold separately) connects in the same way to the other PV Positive and Negative busbars with the green connected to the ground terminal block.

MNPVHV Disco Installation Instructions (continued)

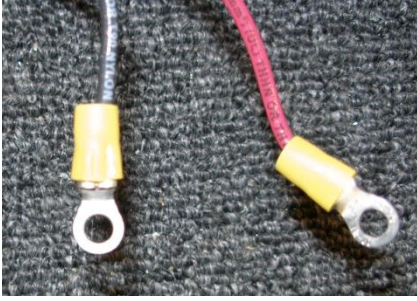

Ring lugs are included to allow easy installation of the MNSPD. If they are to be used, then you would need to strip the wire, push it into the barrel of the ring lug and crimp the barrel with an appropriate crimper. Make sure to pull on the wire after crimping to verify that the crimp is adequate.

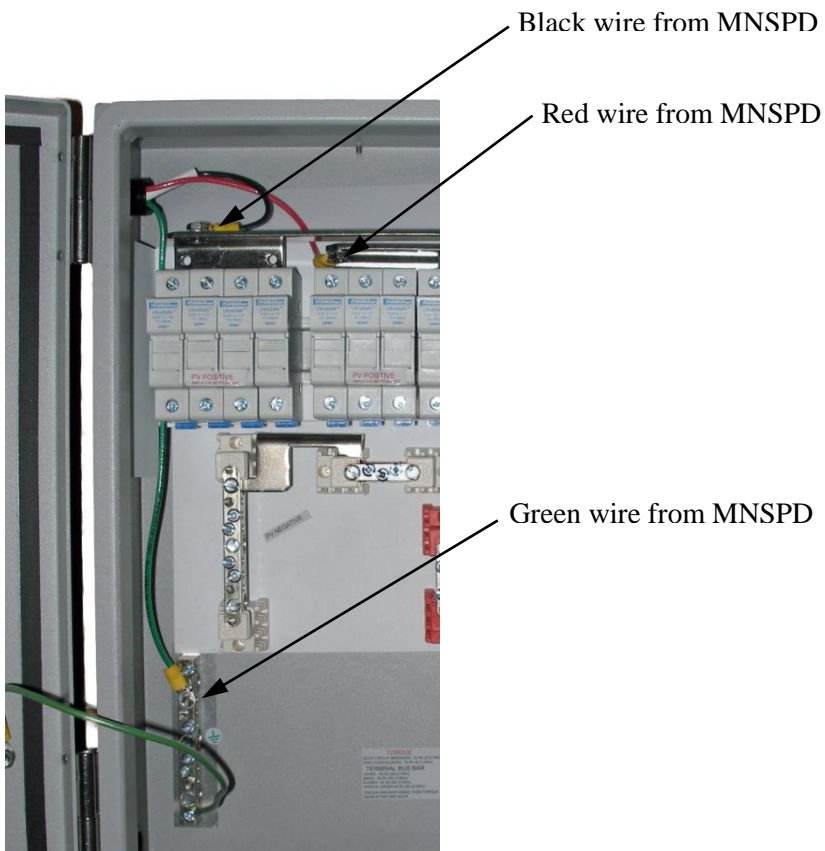

Connections for Non-Isolated.

Refer to the wiring diagrams starting on page 19 for more information or If adding a second MNSPD600 (not included).

MNPVHV Disco Installation Instructions (continued)

Wiring

The MNPVHV Combiners can be configured to meet the combining and disconnecting needs of a wide array of solar system setups. All Combiners are shipped from the factory configured as parallel. Below are the various wiring diagrams. Reconfiguring the combiner is covered in detail starting page 7.

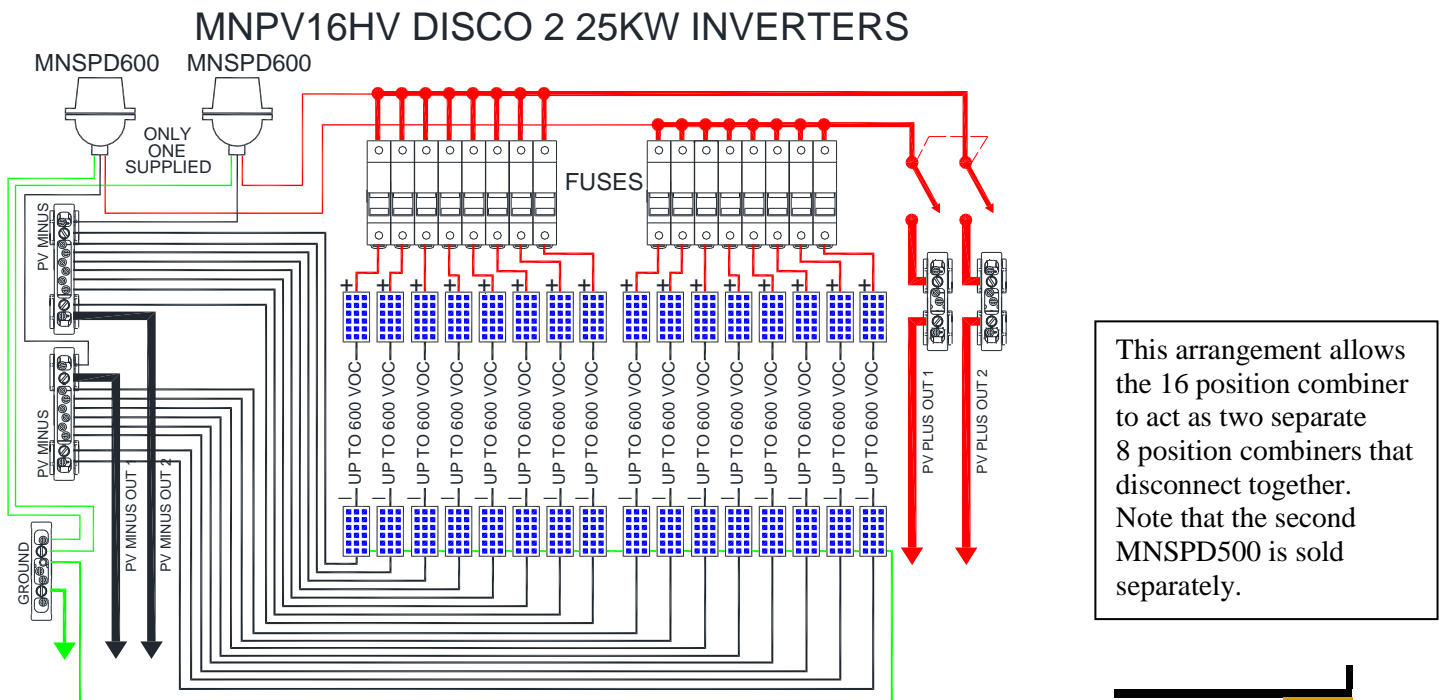
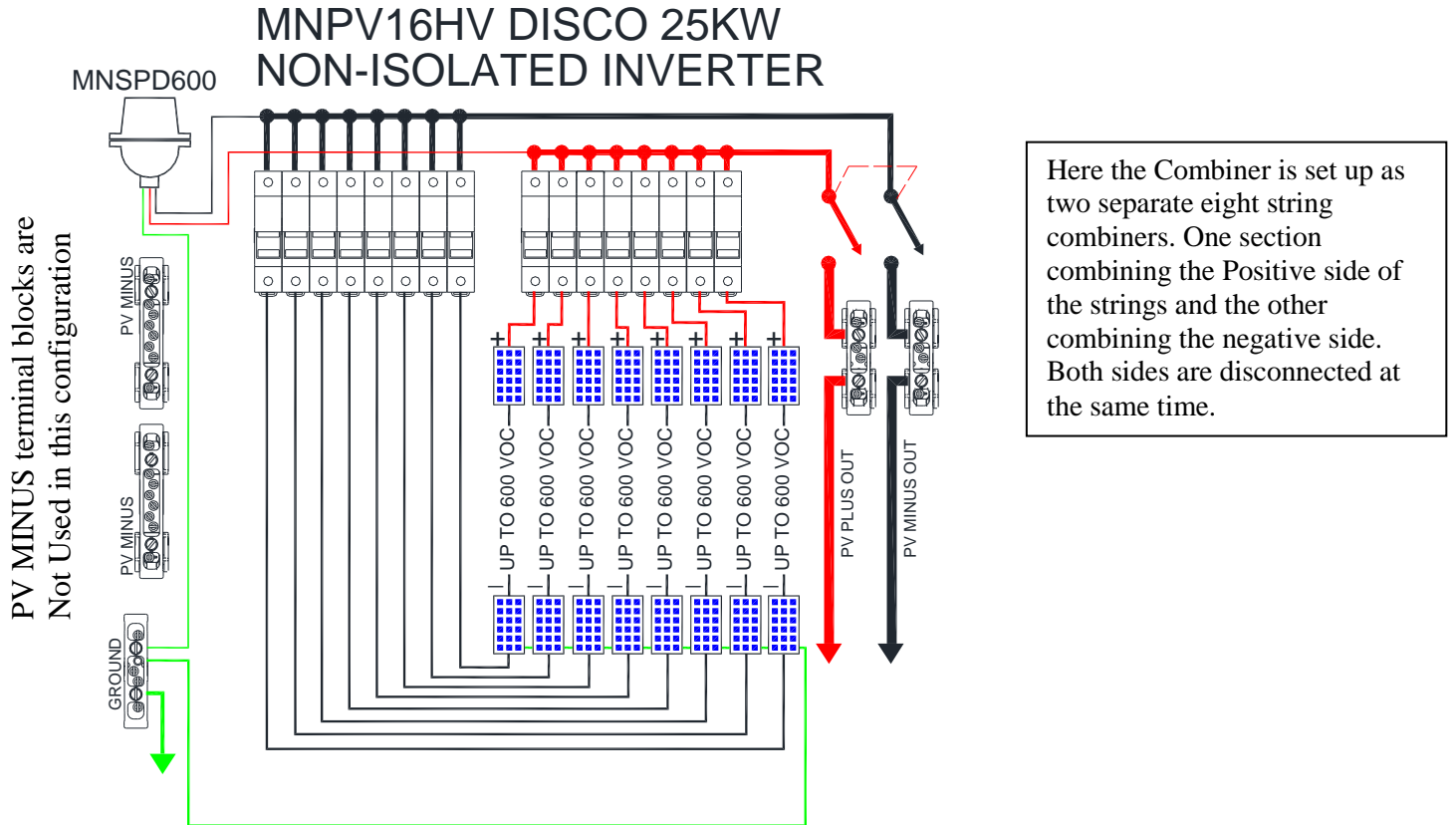

MNPVHV Disco Installation Instructions (continued)

MNPV16HV DISCO-PARALLEL 50KW INVERTER

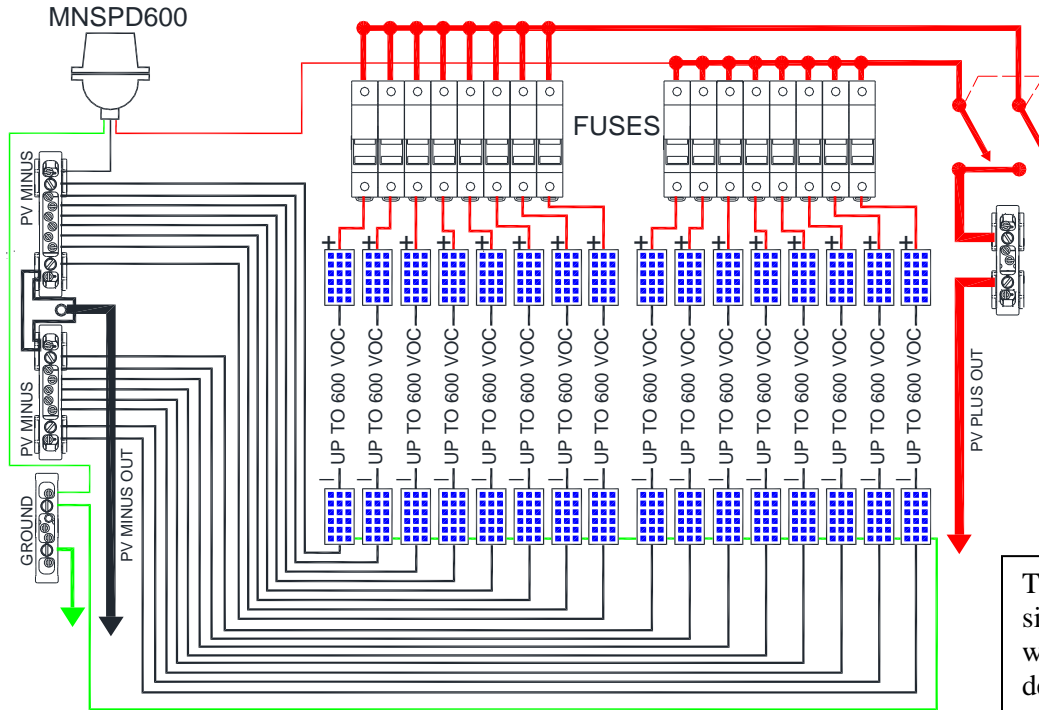

The parallel setup gives you a single 16 position combiner with disconnect. This is the default as shipped configuration

MNPV8HV DISCO NON-ISOLATED INVERTER

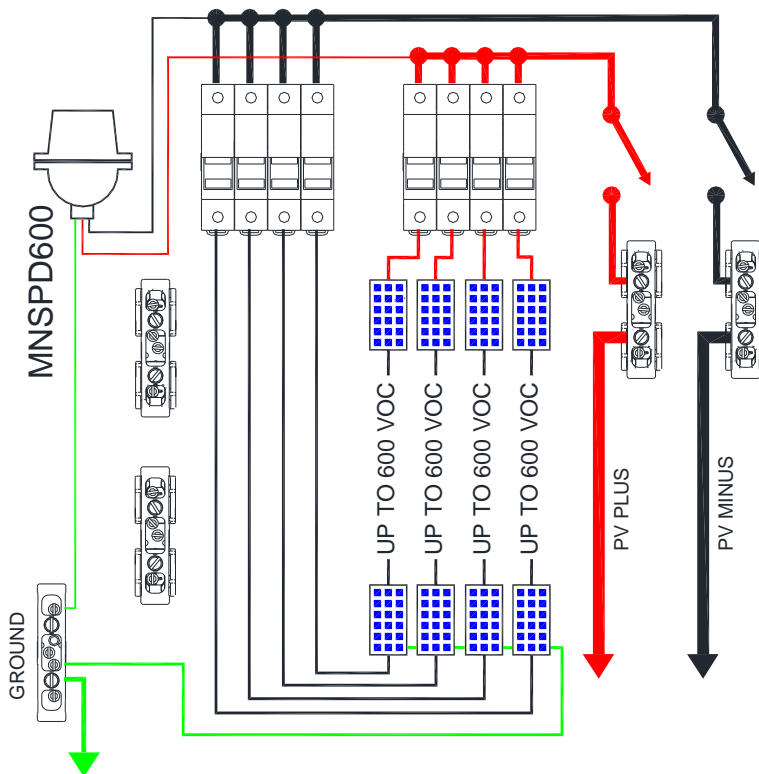

Here the Combiner is set up as two separate four string combiners. One section combining the Positive side of the strings and the other combining the negative side. Both sides are disconnected at the same time.

MNPV8HV DISCO 2 INVERTERS

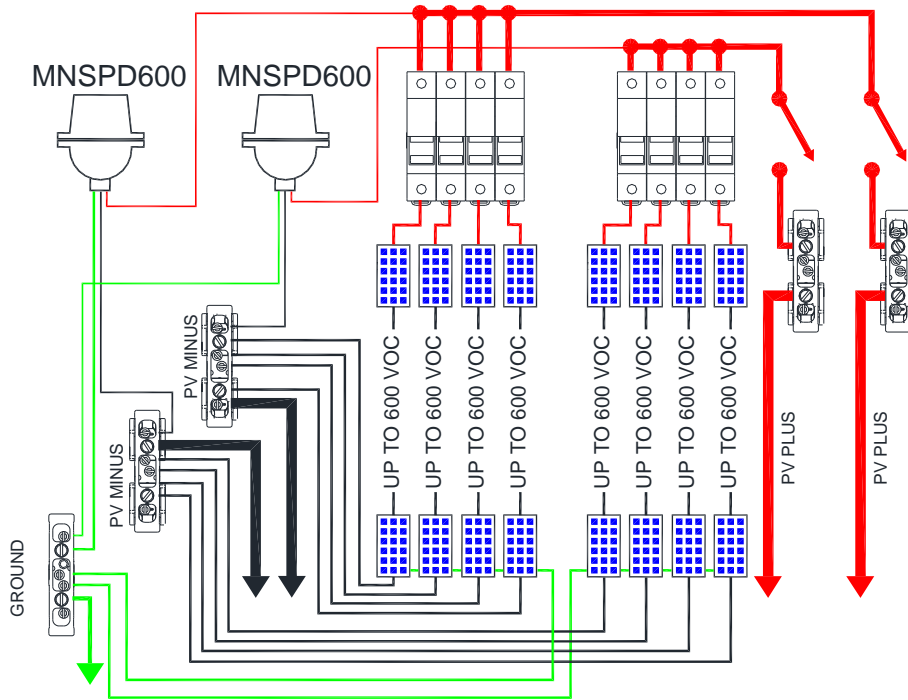

This arrangement allows the 8 position combiner to act as two separate 4 position combiners that disconnect together. Note that the second MNSPD600 is sold separately.

MNPV8HV DISCO-PARALLEL

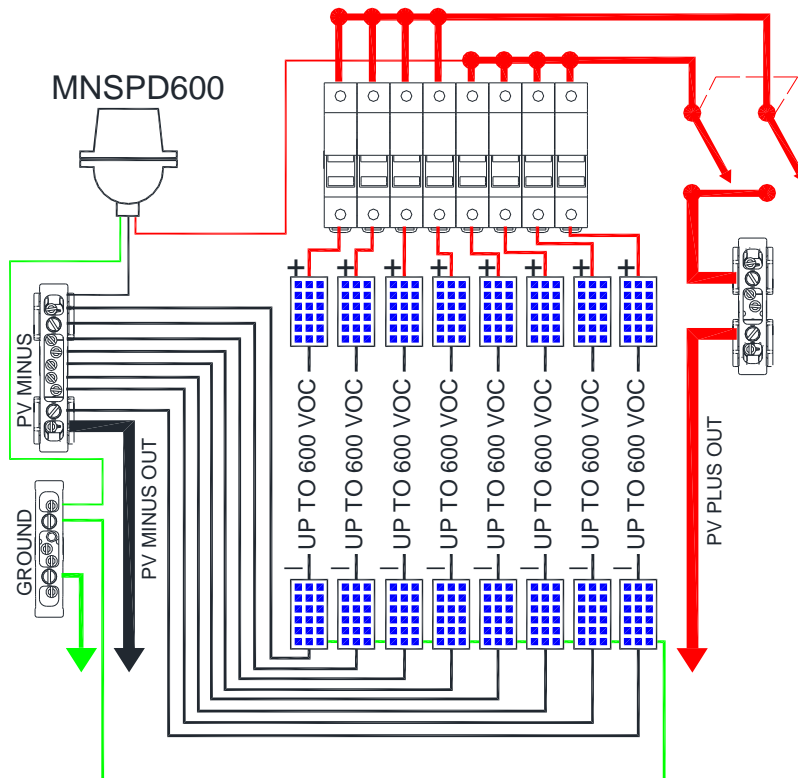

Here both sides of the strings plus and minuses are combined through fuses and both sides are disconnected together. This is the default as shipped configuration

MNPV6HV DISCO

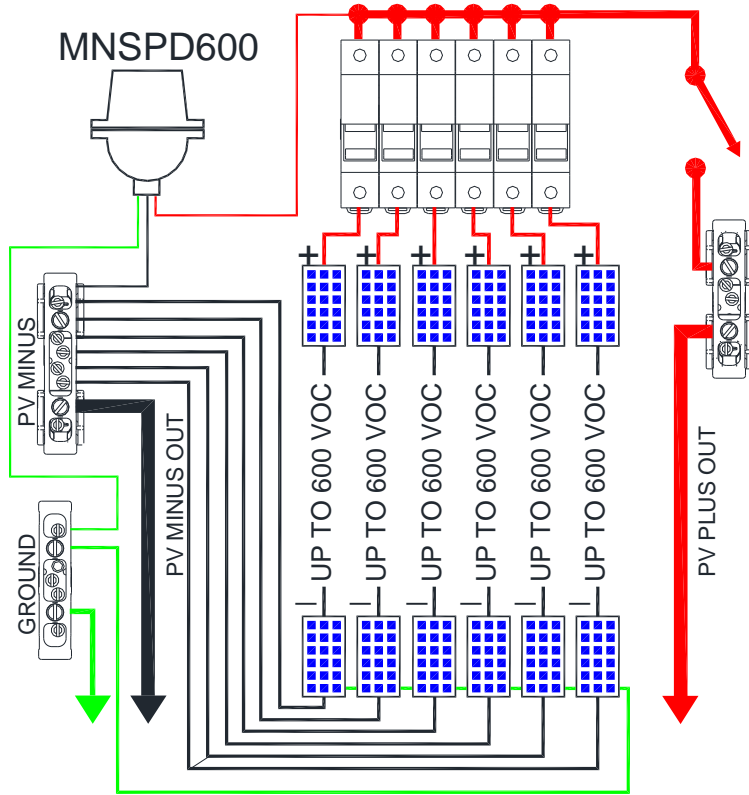

This is the typical wiring for the MNPV6HV Disconnecting Combiner. The MNPV4HV is wired the same but with 4 strings



All Midnite Solar products are assembled under the watchful eye of Midnite the cat.

MNPVHV Disco Installation Instructions (continued)

Optional Accessories



MNBirdhouse

- Located at ground level, the Birdhouse provides a safe means to disconnect high voltage PV arrays from MidNite Disconnecting and Arc Fault combiners.
- Hard wired connection gives positive feedback that the Disconnect on the roof has actually been thrown. Connection is via 600/1000v Cat 5 USE-2 cable
- Up to four separate means of power including battery backup insures that the disconnect will be tripped when the button is pushed
- Voice confirms level of safety (day or night) to the person pushing the button
- Nema 3R UV resistant enclosure
- Able to disconnect multiple PV Disco Arcfault Combiners
- Firefighter Approved
- 600V Cat 5 USE-2 90° cable available from Midnite Solar



When using the Birdhouse with any one of the Disco combiners you must also add the **MNDiscoPSB** Power Supply Board. The Power Supply Board is already incorporated into the Arc Fault combiners. The Power Supply Board is not required when using the Birdhouse with Arc Fault combiners.

MNPVHV Disco Installation Instructions (continued)

Installing the MNDiscoPSB Power Supply PCB:

You will need:

3/16" Slotted screwdriver, #1 Phillips screwdriver, Wire strippers, 1/4" nutdriver and a wire crimper to attach lugs.

First, verify contents of the MNDiscoPSB Kit.



Parts included with MNDiscoPSB kit.

Qty	Description	MidNite Solar PN
1	PCB MNDiscoPSB	8-037-10
1	Formex Insulator	5-144-1
1	Wire 18 AWG Red	9-367-1
1	Wire 18 AWG White	9-390-1
1	Double Ferrule	6-166-1
2	Terminal 18-22 AWG	6-168-1
2	Screw 6-32 X XX	6-060-1
2	Standoff 1/2 Inch	6-154-1

MNPVHV Disco Installation Instructions (continued)

Installing the MNDiscoPSB Power Supply PCB: Continued

Step 1: Remove the top cover and deadfront (Page 3).

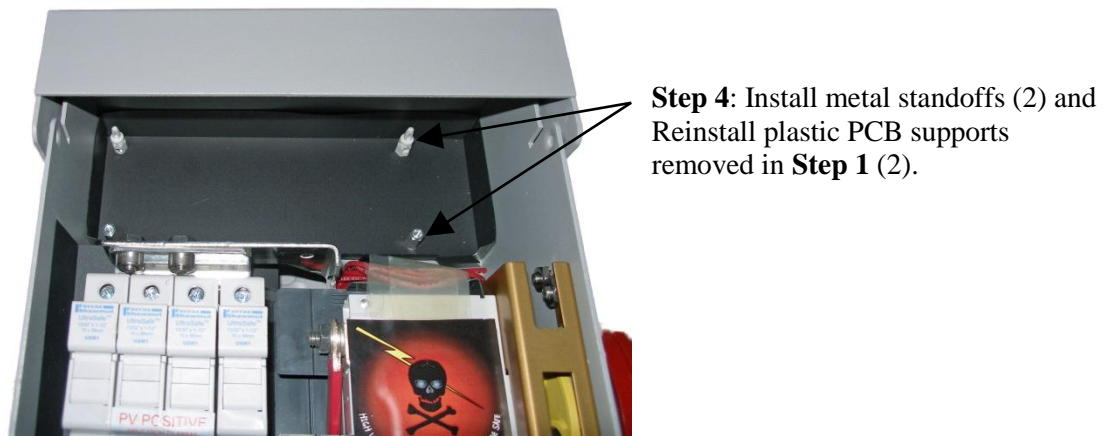
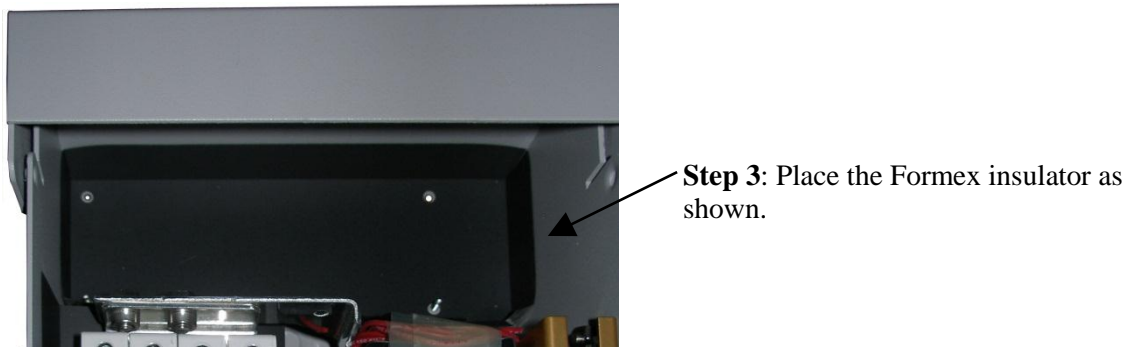
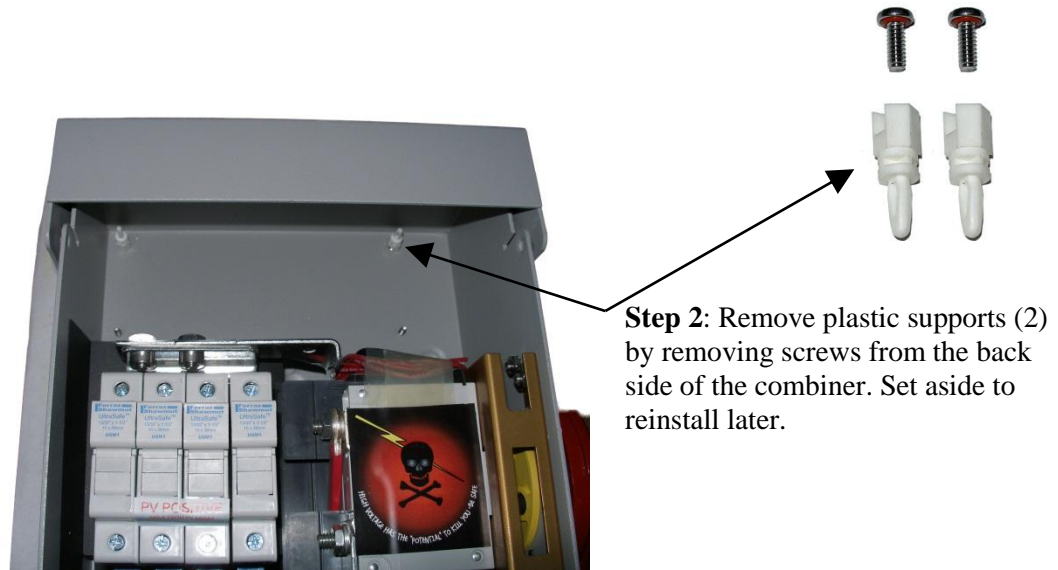

MNPVHV Disco Installation Instructions (continued)

Installing the MNDiscoPSB Power Supply PCB: Continued



Note:
Circuit board is shown without non-removable clear cover.

Step 5A:
Set board in place as shown.



Step 5B:
Secure board with 6-32 screws (2).

Loosen wire bundle from switch
Trim wires to 5" and strip 1/4"



Step 6: Connect the two black wires to The left side of the terminal block marked "BK1" and "BK2". Connect the two red wires to the right side of the terminal block marked "S1" and "S2".

Installing the MNDiscoPSB Power Supply PCB: Continued



Step 7: Strip one end on the red and white wires included in the kit ¼” and connect them as shown with the red wire on the left side of the terminal block marked “PV+” and the white wire on the right side marked “PV-“. Route the wires downward under the large switch.

Step 8:

Installing the included MNSPD Surge protector with the MNDiscoPSB.

First, select the mounting location for the MNSPD. There are several knockouts located on the sides and bottom that can be used for this. Remove the desired knockout, pull the MNSPD wires through and secure with the supplied nut.



MNSPD Shown installed in left side knockout.

Crimp one of the small red terminals on the red wire from the circuit board terminal block. Be sure to make a strong secure connection. The purpose of this terminal is to allow the 18 AWG wire to be held securely into the terminal strip.

The white wire from the circuit board terminal block may be crimped into the yellow terminal along with the black wire from the MNSPD or it may be crimped by itself into the second red terminal.

Installing the MNDiscoPSB Power Supply PCB: Continued

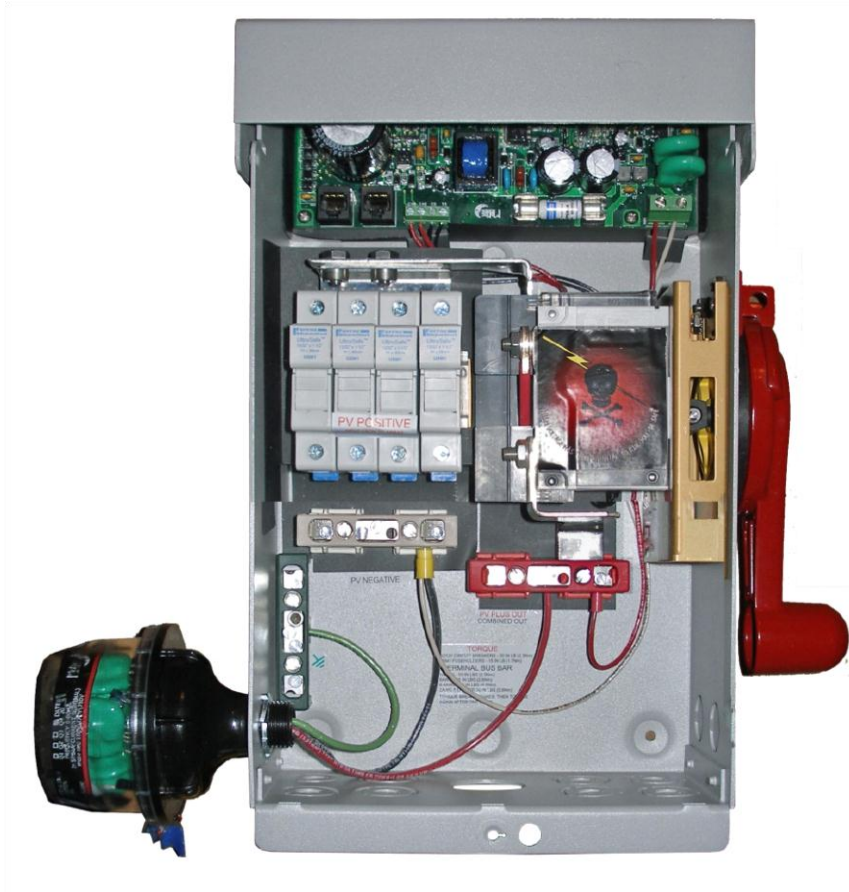

MNPVHV4 TYE 3R Shown wired with MNDiscoPSB power supply board and MNSPD surge protector.

Step 9:

Verify your work and replace deadfront and top cover.



MNPVHV Disco Installation Instructions (continued)

MNPV4HV TYPE 3R, INCLUDED/REPLACEMENT PARTS: MIDNITE SOLAR PART NUMBER

4 EACH FUSES, 9-084-1
DEADFRONT 5-101-1

MNPV6HV TYPE 6X, INCLUDED/REPLACEMENT PARTS: MIDNITE SOLAR PART NUMBER

6 EACH BLACK TWO WIRE STRAIN RELIEFS, 9-328-1
6 EACH BLACK STRAIN RELIEF NUTS, 9-328-1
6 EACH STRAIN RELIEF WASHERS, 9-139-1
SURGE PROTECTION DEVICE MNSPD 600V
6 EACH FUSES, 9-084-1
DEADFRONT 5-120-1

MNPV8HV TYPE 3R, INCLUDED/REPLACEMENT PARTS: MIDNITE SOLAR PART NUMBER

8 EACH BLACK TWO WIRE STRAIN RELIEFS, 9-328-1
8 EACH BLACK STRAIN RELIEF NUTS, 9-328-1
8 EACH STRAIN RELIEF WASHERS, 9-328-1
SURGE PROTECTION DEVICE 600V
BUSBAR, NEGATIVE OUT 3-272-1
BUSBAR, NEGATIVE OUT 2 3-315-1
HALF INCH SILICONE CONDUIT HOLE PLUG 5-107-1
CONDUIT ADAPTOR $\frac{3}{4}$ " – $\frac{1}{2}$ " 5-118-1
CONDUIT ADAPTOR NUT 5-119-1
CONDUIT ADAPTOR GASKET 5-126-1
8 EACH FUSES, 9-084-1
DEADFRONT 5-112-1

MNPV8HV TYPE 4X, INCLUDED/REPLACEMENT PARTS: MIDNITE SOLAR PART NUMBER

8 EACH BLACK TWO WIRE STRAIN RELIEFS, 9-328-1
8 EACH BLACK STRAIN RELIEF NUTS, 9-328-1
8 EACH STRAIN RELIEF WASHERS, 9-328-1
SURGE PROTECTION DEVICE MNSPD 600V
BUSBAR, NEGATIVE OUT 3-272-1
BUSBAR, NEGATIVE OUT 2 3-315-1
HALF INCH SILICONE CONDUIT HOLE PLUG 5-107-1
CONDUIT ADAPTOR $\frac{3}{4}$ " – $\frac{1}{2}$ " 5-118-1
CONDUIT ADAPTOR NUT 5-119-1
CONDUIT ADAPTOR GASKET 5-126-1
8 EACH FUSES, 9-084-1
DEADFRONT 5-112-1

MNPV16HV TYPE 4X, INCLUDED/REPLACEMENT PARTS: MIDNITE SOLAR PART NUMBER

16 STRAIN RELIEFS WITH NUTS 5-328-1
SILICON WASHERS 5-139-18
ADAPTORS 5-118-1
8 NUTS 5-119-1
8 WASHERS 5-126-1
8 PLUGS 5-107-1
SURGE PROTECTION DEVICE MNSPD 600V
BUSBAR, NEGATIVE OUT 2 3-295-1
BUSBAR, OUT 3 3-321-1
HALF INCH SILICONE CONDUIT HOLE PLUG 5-107-1
CONDUIT ADAPTOR $\frac{3}{4}$ " – $\frac{1}{2}$ " 5-118-1
CONDUIT ADAPTOR NUT 5-119-1
CONDUIT ADAPTOR GASKET 5-126-1
16 EACH FUSES, 9-084-1
DEADFRONT 5-125-1

MIDNITE SOLAR INC. LIMITED WARRANTY

MidNite Solar Power electronics, sheet metal enclosures and accessories

Midnite Solar Inc. warrants to the original customer that its products shall be free from defects in materials and workmanship for a period of five (5) years. At its option, Midnite Solar will repair or replace at no charge any Midnite product that proves to be defective within such warranty period. This warranty shall not apply if the Midnite Solar product has been damaged by unreasonable use, accident, negligence, service or modification by anyone other than Midnite Solar, or by any other causes unrelated to materials and workmanship. The original consumer purchaser must retain original purchase receipt for proof of purchase as a condition precedent to warranty coverage. To receive in-warranty service, the defective product must be received no later than two (2) weeks after the end of the warranty period. The product must be accompanied by proof of purchase and Return Authorization (RA) number issued by Midnite Solar. For an RMA number contact Midnite Solar Inc, 17722 67th Ave NE unit C, Arlington, WA 98223 (425) 374-9060. Purchasers must prepay all delivery costs or shipping charges to return any defective Midnite Solar product under this warranty policy.

Except for the warranty that the products are made in accordance with the specifications therefore supplied or agreed to by customer, MIDNITE SOLAR MAKES NO WARRANTY EXPRESSED OR IMPLIED, AND ANY IMPLIED WARRANTY OF MERCHANTABILITY OR FITNESS FOR A PARTICULAR PURPOSE WHICH EXCEEDS THE FOREGOING WARRANTY IS HEREBY DISCLAIMED BY MIDNITE SOLAR AND EXCLUDED FROM ANY AGREEMENT MADE BY ACCEPTANCE OF ANY ORDER PURSUANT TO THIS QUOTATION. MIDNITE SOLAR WILL NOT BE LIABLE FOR ANY CONSEQUENTIAL DAMAGES, LOSS OR EXPENSE ARISING IN CONNECTION WITH THE USE OF OR THE INABILITY TO USE ITS GOODS FOR ANY PURPOSE WHATSOEVER. MIDNITE SOLAR'S MAXIMUM LIABILITY SHALL NOT IN ANY CASE EXCEED THE CONTRACT PRICE FOR THE GOODS CLAIMED TO BE DEFECTIVE OR UNSUITABLE.

Products will be considered accepted by customer unless written notice to the contrary is given to MIDNITE SOLAR within ten (10) days of such delivery to customer. MIDNITE SOLAR shall not in any case be liable for any event occurring or defect discovered with regard to said product unless written notice thereof is given to MIDNITE SOLAR within ninety (90) days of such product delivery to customer. MIDNITE SOLAR is not responsible for loss or damage to products owned by customer and located on MIDNITE SOLAR'S premises caused by fire or other casualties beyond MIDNITE SOLAR's control. This warranty is in lieu of all other warranties expressed or implied.



MIDNITE SOLAR INC. 17722 67TH AVE NE UNIT C ARLINGTON, WA 98223
Email: info@midnitesolar.com PH: 425-374-9060 FAX: 360-691-6862