



FLEXware 1000

User's Guide

Includes Mounting, Installation, and
Product Registration



OutBack Power Systems FLEXware is a system of modular aluminum mounting hardware and installation components designed for convenient system installation and integration.

About OutBack Power Systems

OutBack Power Systems is a leader in advanced energy conversion technology. Our products include true sine wave inverterchargers, a maximum power point charge controller, system communication components, as well as breaker panels, breakers, accessories, and assembled systems.

Notice of Copyright

FLEXware 1000 Manual Copyright © 2006 All rights reserved.

Disclaimer

UNLESS SPECIFICALLY AGREED TO IN WRITING, OUTBACK POWER SYSTEMS:

(a) MAKES NO WARRANTY AS TO THE ACCURACY, SUFFICIENCY OR SUITABILITY OF ANY TECHNICAL OR OTHER INFORMATION PROVIDED IN ITS MANUALS OR OTHER DOCUMENTATION.

(b) ASSUMES NO RESPONSIBILITY OR LIABILITY FOR LOSS OR DAMAGE, WHETHER DIRECT, INDIRECT, CONSEQUENTIAL OR INCIDENTAL, WHICH MIGHT ARISE OUT OF THE USE OF SUCH INFORMATION. THE USE OF ANY SUCH INFORMATION WILL BE ENTIRELY AT THE USER'S RISK.

Date and Revision

September 25, 2006 1.0

Contact Information

OutBack Power Systems
19009 62nd Ave. NE
Arlington, WA 98223
Phone (360) 435-6030
Fax (360) 435-6019
www.outbackpower.com

Requirements and Warnings

The OutBack FLEXware 1000 enclosures (FW1000-AC and FW1000-DC) are listed by ETL as an indoor enclosure to UL standard UL 508A Industrial Control Panels.

This enclosure is intended for battery circuits configured for 12 to 48 volts nominal.

Grounding Instructions – Each enclosure should be connected to a grounded, permanent wiring system. For most installations, the negative battery conductor should be bonded to the grounding system at one (and only one) point in the DC system. All installations should comply with all national and local codes and ordinances. System grounding as required by the National Electric Code, ANSI /NFPA 70-1996, is the responsibility of the system installer.

The equipment ground on FLEXware1000 is marked with this symbol: 

FLEXware is designed for indoor mounting only with appropriate fasteners and a secure mounting surface that can handle the full weight of an assembled system.

Welcome to OutBack Power Systems' FLEXware

FLEXware is a convenient all-aluminum power system offering simpler, code-compliant installation of OutBack power electronics components. Three versions of FLEXware are available:

- FLEXware 250 for single FX Series Inverter/Charger installations along with the desired AC and DC disconnects
- FLEXware 500, which supports up to two FXs and two MX Charge Controllers, accommodating both split-phase and/or higher power output as needed
- FLEXware 1000 accommodates up to four FXs and four MX Charge Controllers

Please Note: Both the FLEXware 500 and the FLEXware 1000 power systems provide locations for FW-X240 Auto-Transformers, multiple DC shunts and other essential components required in higher kW systems.

Getting to Know FLEXware 1000

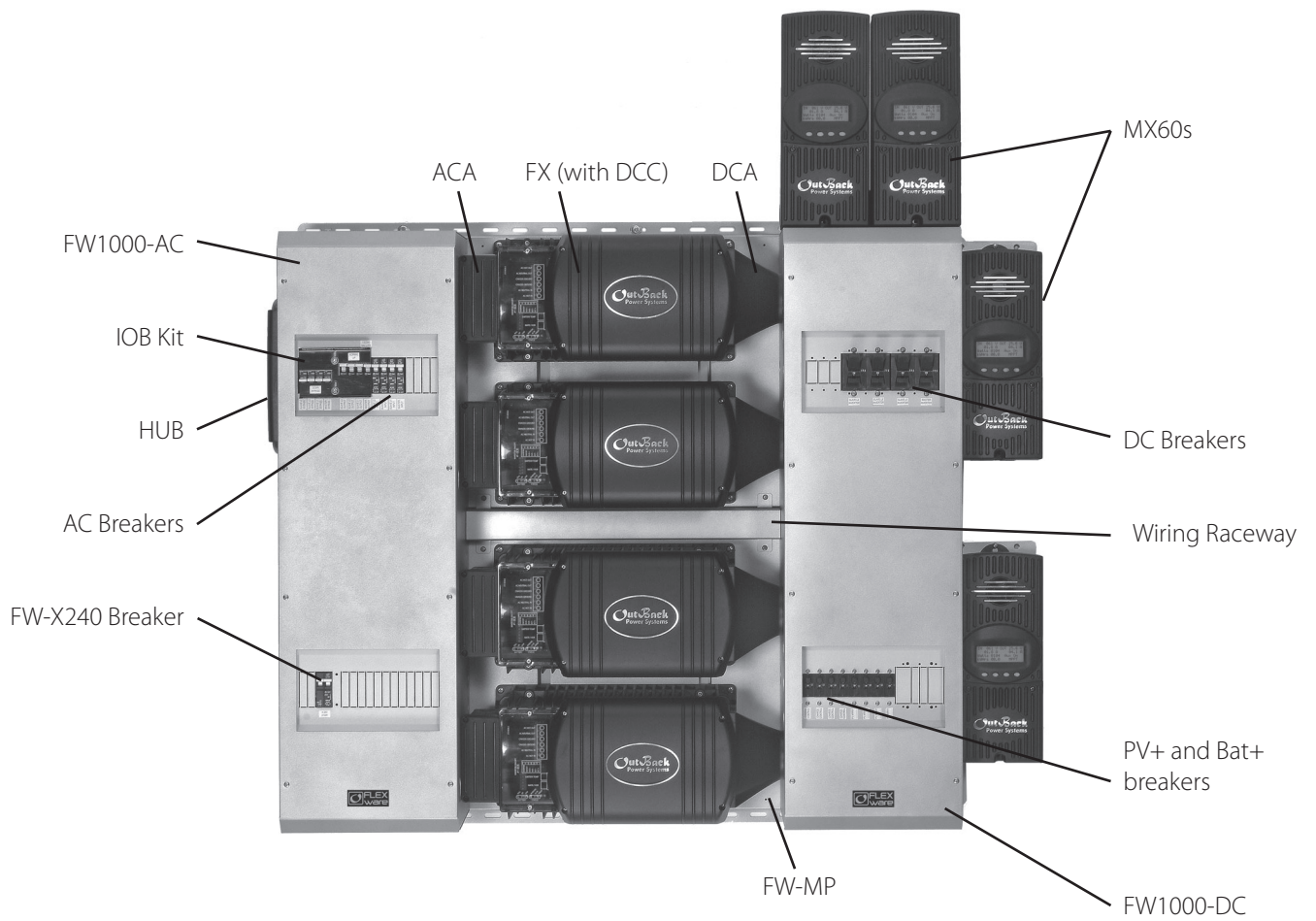

Figure 1: FLEXware 1000 System

Knockouts and Dimensions

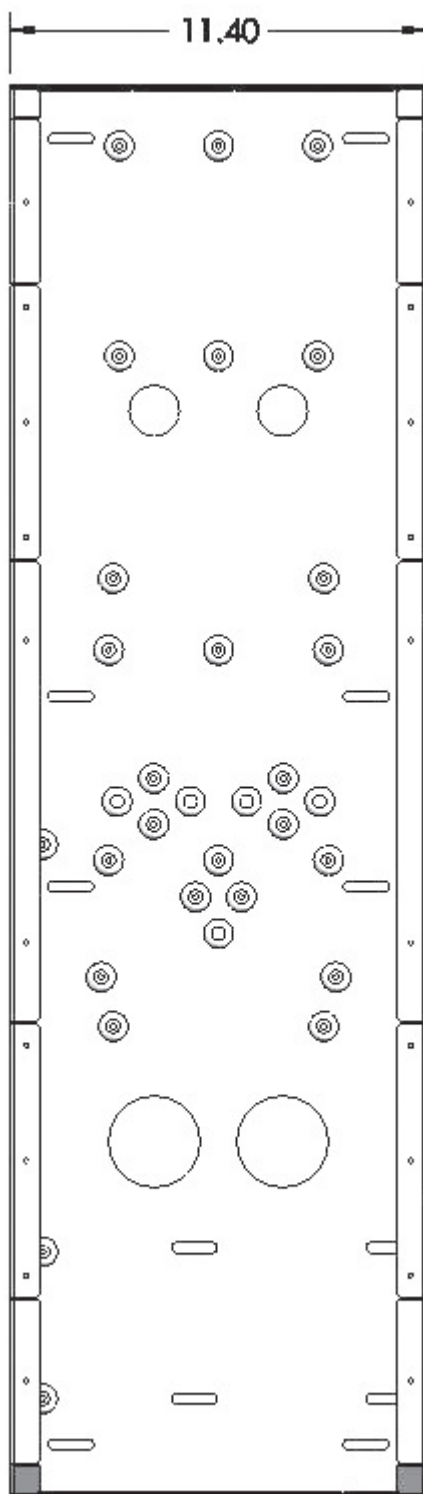
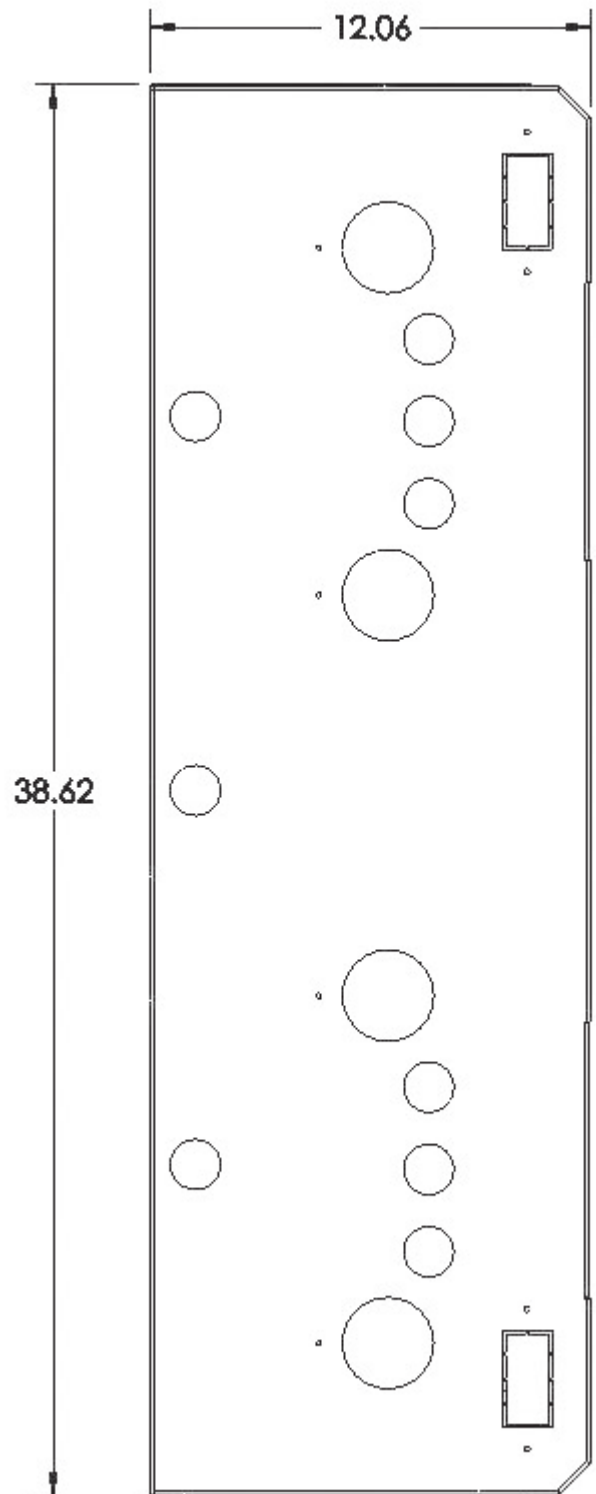

Figure 2: Front View



Side View

A *complete* FLEXware 1000 System consists of the following in addition to the FW1000-AC and FW1000-DC:

- two FLEXware Mounting Plates (FW-MP)
- FLEXware Wiring Raceway (included with AC chassis)
- four FX Series Inverter/Chargers
- AC Conduit Adapter (ACA) and a DC Conduit Adapter (DCA), which connect each FX to the FW1000-AC and FW1000-DC
- MX60 Charge Controller(s) (normally part of this system) and mounting brackets
- AC and DC breakers including a specific AC Input/Output/Bypass Breaker (IOB) Kit
- bus bars and DC current shunts as required per specific installation
- DC and AC ground fault protection

Some systems will work optimally with a FW-X240 Auto-Transformer installed.

Note: Be sure you have all the parts required for your intended system installation. As every installation is different, consult with your dealer or installer for further information.

FLEXware 1000 Parts List

FLEXware 1000 consists of the FW1000-AC and FW1000-DC. Each is an aluminum chassis for mounting AC and DC breakers, respectively, along with the components listed below:

FW1000-AC components:

- aluminum enclosure
- DIN rail bracket
- TBB-GROUND
- Breaker and Bypass Mounting Bracket
- FW Wiring Raceway with mounting hardware
- metal hanging straps for combining two FW-MPs

FW1000-DC components:

- aluminum enclosure
- 500 amp shunt with TBB
- TBB-GROUND
- one FW breaker bus
- two shunt bus bars
- two DC Breaker Mounting Brackets
- FXW1000-DC Hardware Kit

Installation Tips

- Never use less than the minimum recommended number and type of fasteners when installing the FLEXware Mounting Plates.
- Each FX weighs in excess of 50 lbs and is often more easily installed by two people rather than one.
- Be sure the DC enclosure is secured to the FLEXware Mounting Plate before attaching the MX Charge Controller to it.
- Installation of each enclosure and breakers is normally easier by removing the breaker brackets first. Do not remove any breaker knockouts from these brackets without referring to the chosen AC IOB kits and DC breaker selections first.
- It is also easier if all conduit knockouts are removed before mounting the enclosures.

Mounting and Installation

FLEXware 1000 is designed for mounting on the FLEXware Mounting Plate (FW-MP). Although the components can be secured to other surfaces, the FW-MP is an engineered platform designed for the FLEXware 1000 installation. This manual illustrates such an installation. ***OutBack does not endorse other installation methods and therefore cannot recommend fasteners or other means of attachment due to the variety of installations possible in the field.***

Please see the FLEXware Mounting Plate Instructions for further information.

In addition to installing the AC and DC chassis, a typical installation includes four FX Series Inverter/Chargers, one or more MX Charge Controllers, a HUB Communications Manager, and AC and DC Conduit Adapters. The installation of these components is also displayed in these instructions.

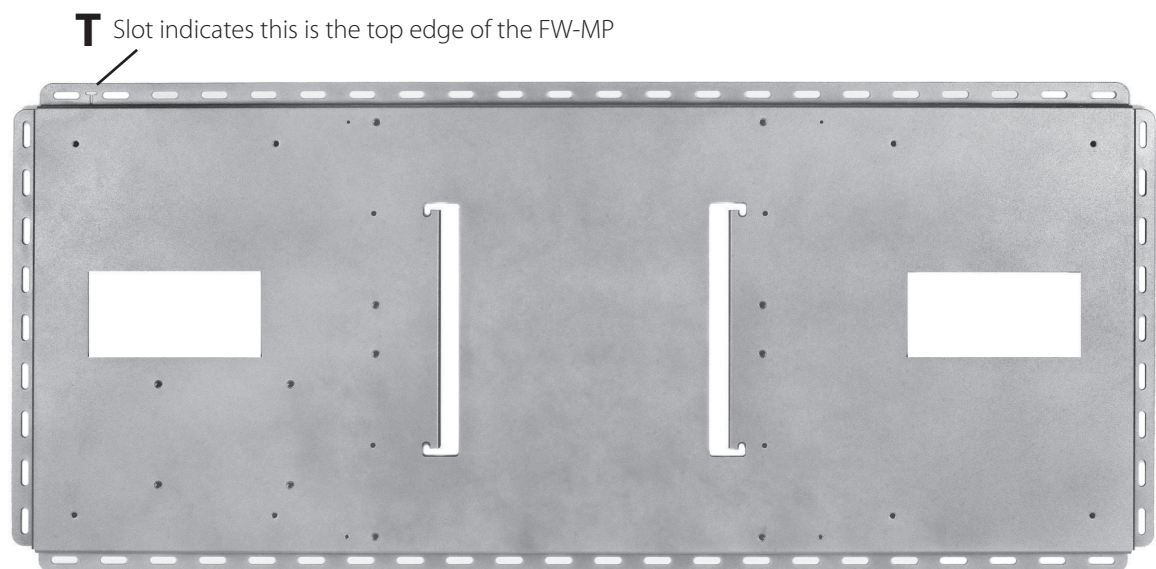

Figure 3: FLEXware Mounting Plate

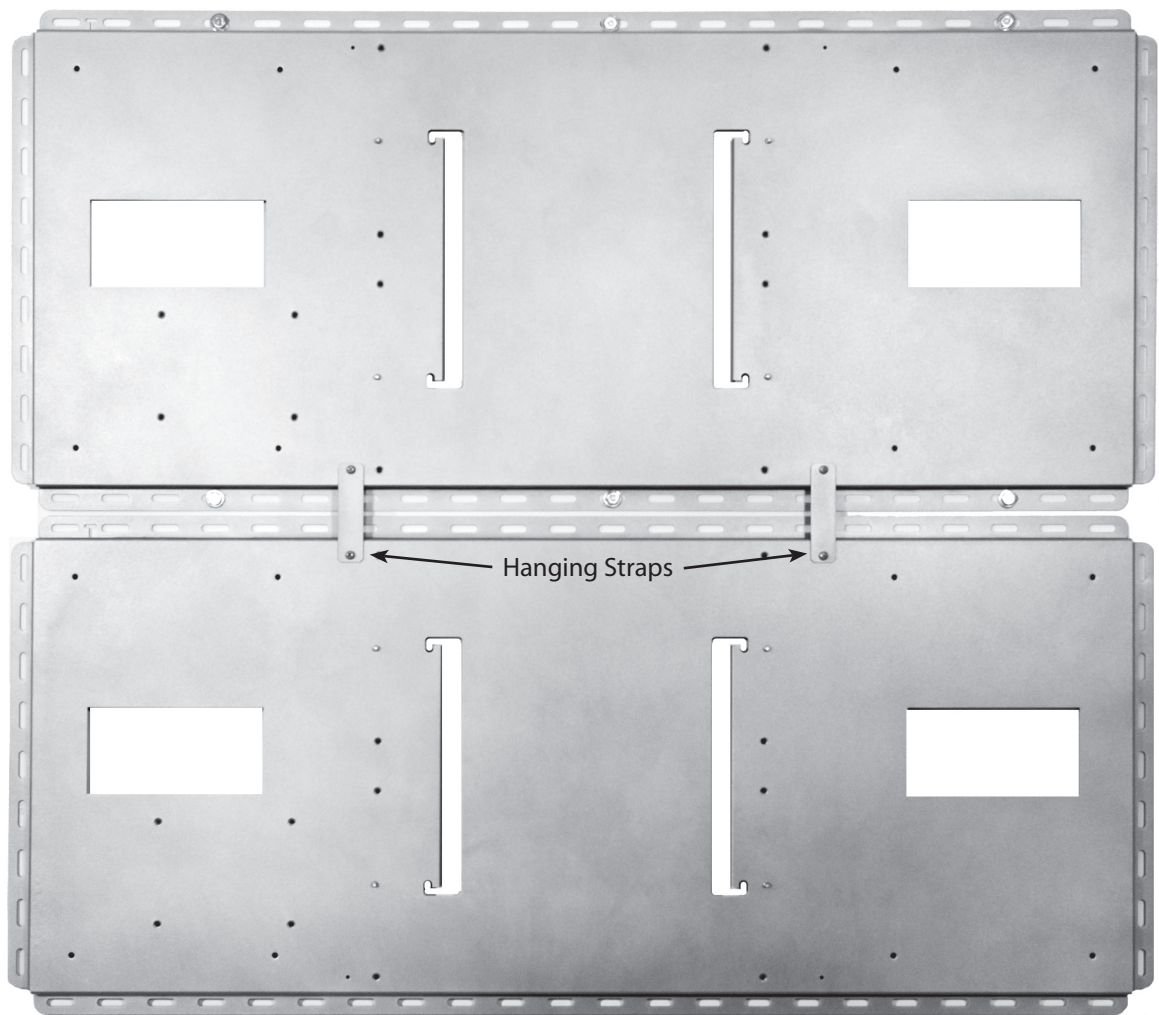

Figure 4: Two mounting plates installed

Note: Check that both FW-MPs are level as per the FLEXware Mounting Plate Installation Manual. If space is restricted, the FW-MPs can be installed vertically.

With the Mounting Plate **and the hanging screws** (for the FX Series Inverter/Chargers) installed, install the FXs.

- Start with the top FX.
- Hang the FX on the hanging screws, but continue to hold onto it.
- Loosely install four M6 X 20 mm screws, included with the FW-MP, one in each corner; tighten them when all four are installed and the FX is aligned.
- Install the remaining FXs in the same manner.



Figure 5: Four FXs installed on FW-MPs

Note: The hanging straps are now removed.

Installation of the AC Chassis and DC Chassis

After the FXs are installed, mount the AC chassis and the DC chassis in either order.

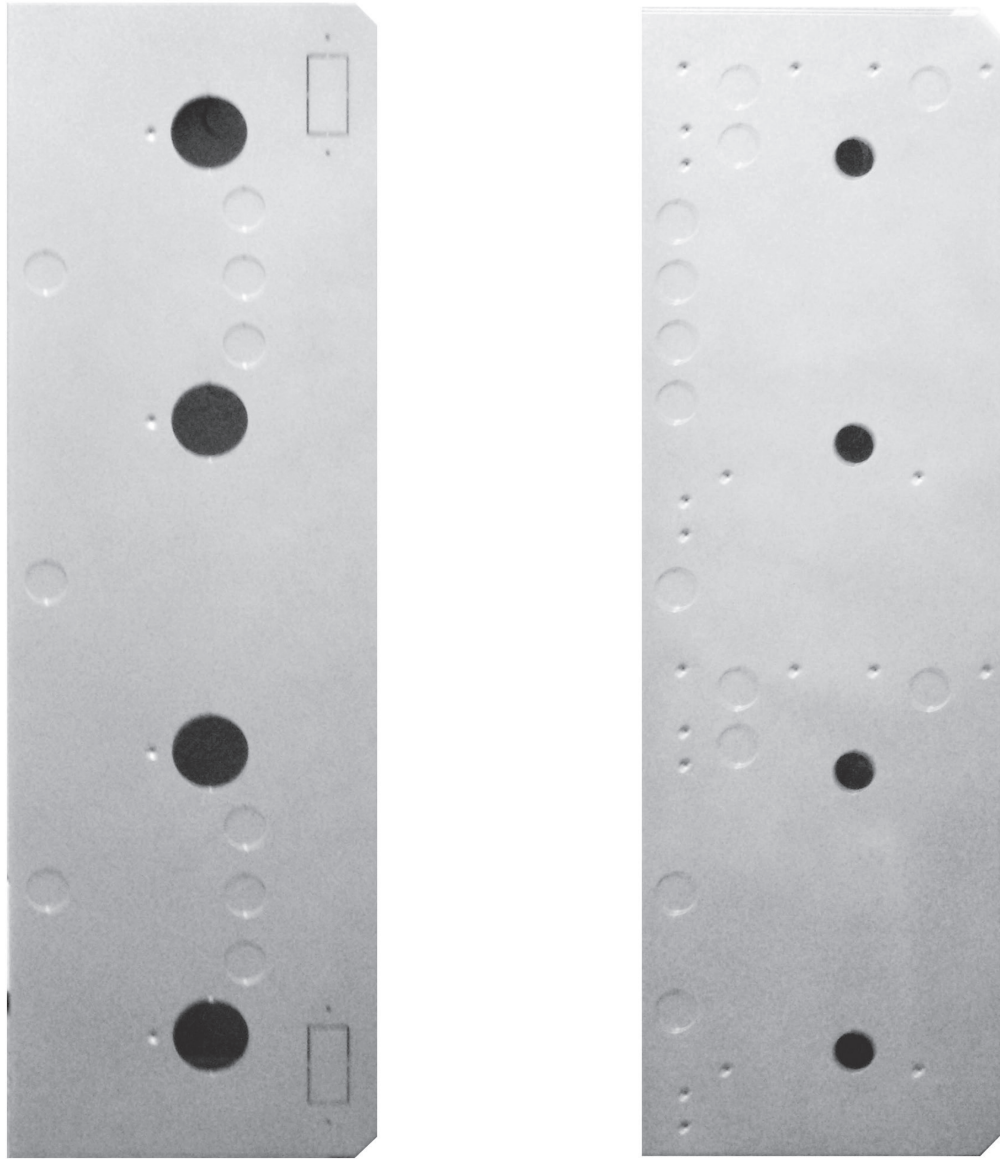

Figure 6: It is easier to remove the appropriate side knockouts from both the AC and DC chassis before installing either of them. If needed, the back knockouts must be removed before installation.

When installing the AC chassis and the DC chassis:

- Either chassis can be installed first, the order is not important.
- Only loosely install the eight screws securing each chassis. The screws will be tightened later.

To install the chassis:

- Hold each chassis up to its respective mounting holes on the FW-MP.
- Place the, M6 X 10mm machine screws through the chassis and into the holes shown in Figure 7 tightening only enough to keep the chassis in place.

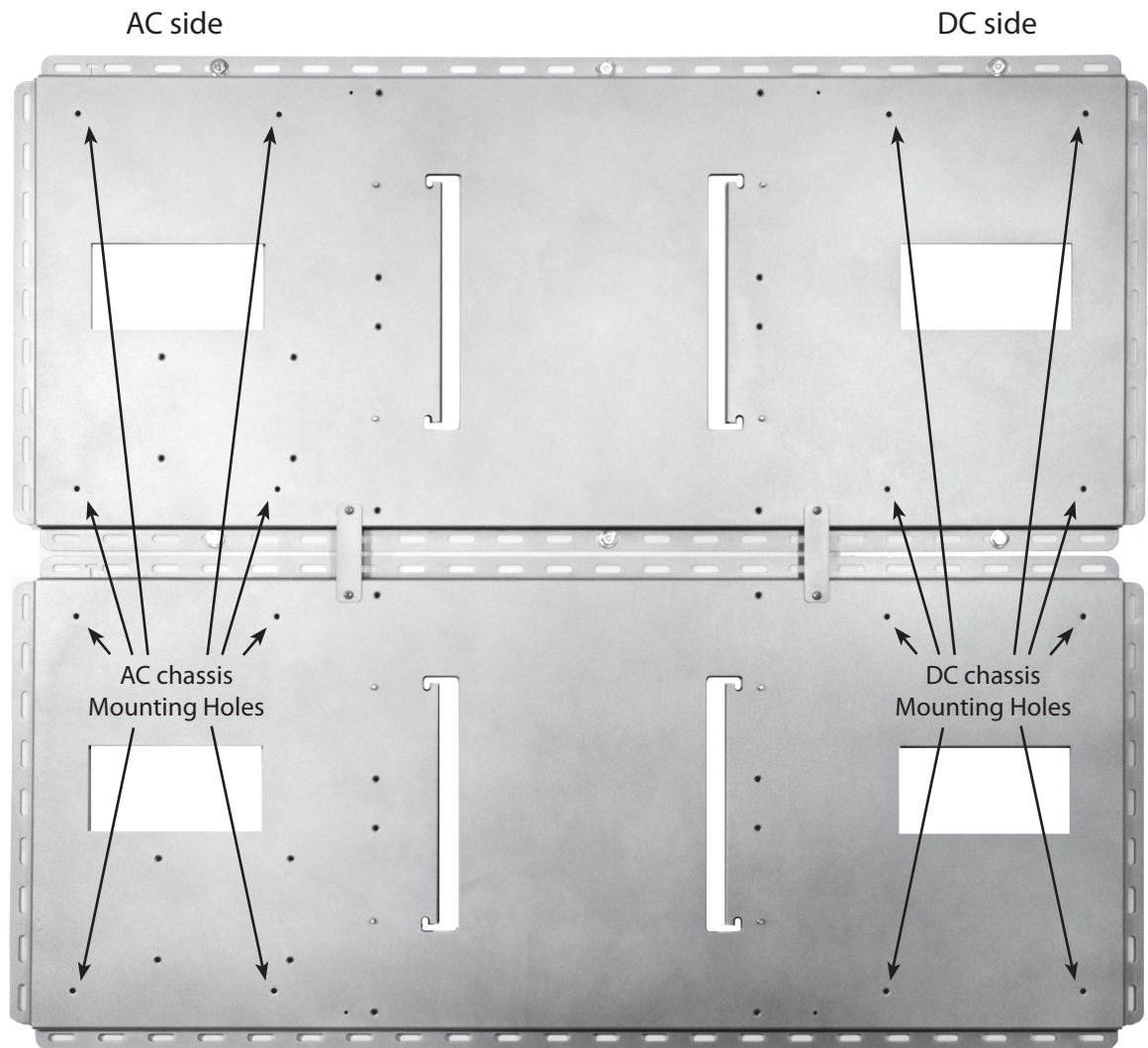

Figure 7: Chassis Mounting Holes

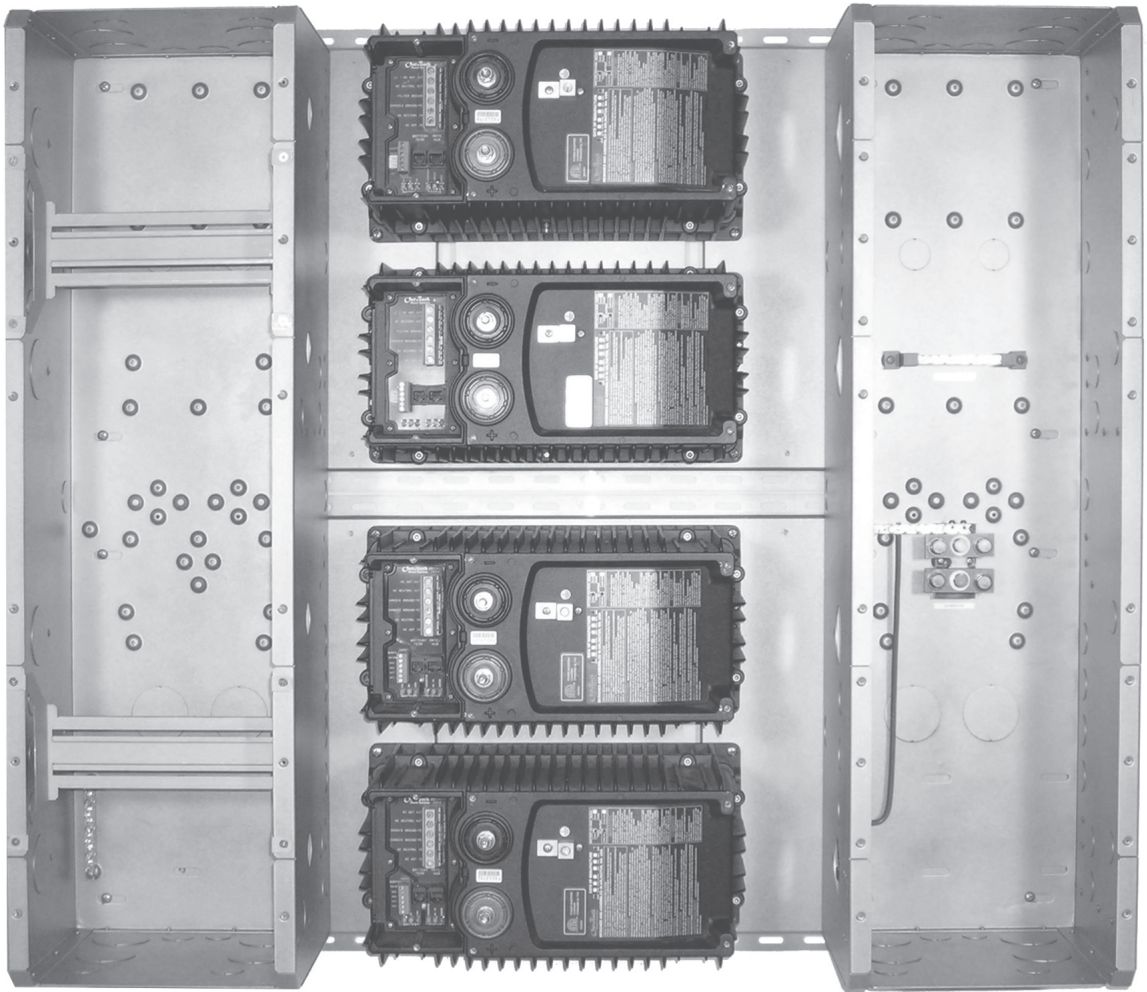

Figure 8: AC and DC Chassis mounted

With each chassis loosely mounted, the AC Conduit Adapter (ACA) and DC Conduit Adapter (DCA) are installed on the FX.

- Remove the clear plastic AC cover and AC Conduit Plate from each FX.

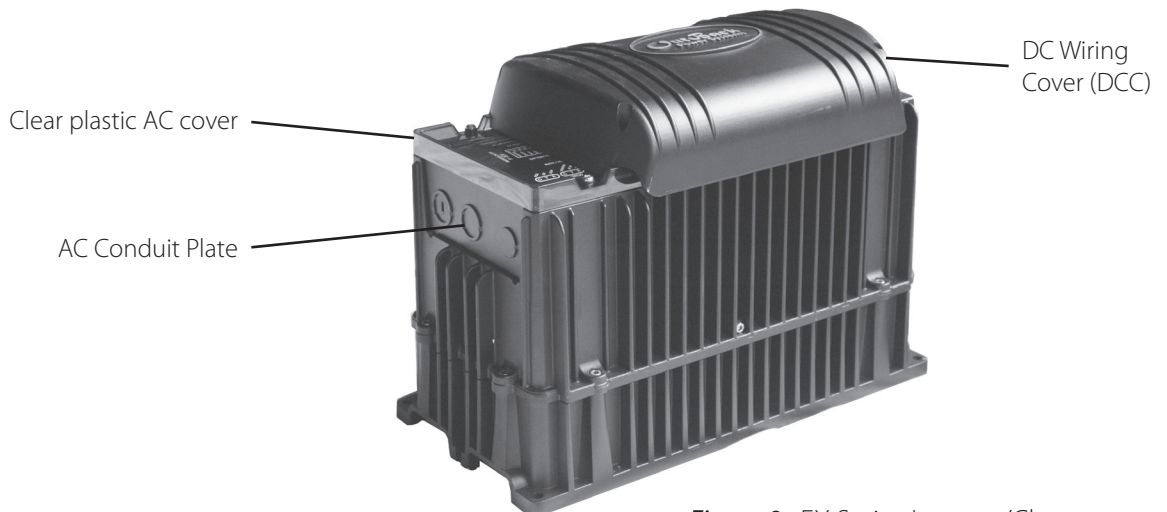

Figure 9: FX Series Inverter/Charger

- Line up either the ACA or DCA (conduit adapters) on its respective side of an FX, starting at the top.
- To attach a DCA, line up its two screw holes with the upper and lower right DCC screw holes.
- When lined up, loosely install the upper screw to hold the DCA in place (screw can be removed later when the DCC is installed).
- Slide the DC chassis over snug against the DCA (the screw slots in each chassis are oval-shaped to allow for movement) so the DCA lines up with the conduit adapter hole on the chassis.
- Install the plastic bushing in this hole (see Figure 11).
- Install the remaining DCA(s) in this same manner. After inserting the bushing into the top DCA, the remaining DCA(s) will line up and the other bushings can be installed.
- With all the DCA's aligned with the DC chassis and the bushings installed, tighten the DC chassis screws against the FW-MP.

Each ACA fits against the AC chassis.

A single screw holds the DCA Conduit Adapter in place. Slide the DC chassis against each DCA to line it up with the plastic bushing.

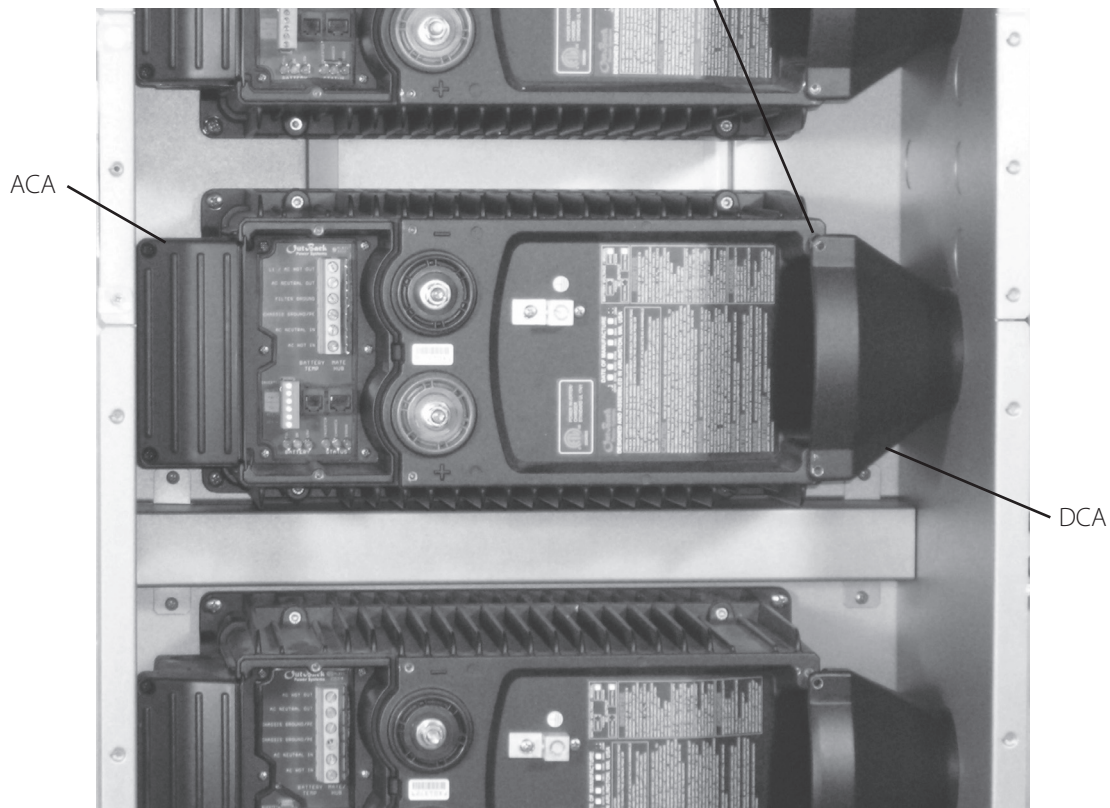

Figure 10: ACAs (left) and DCAs (right) in place

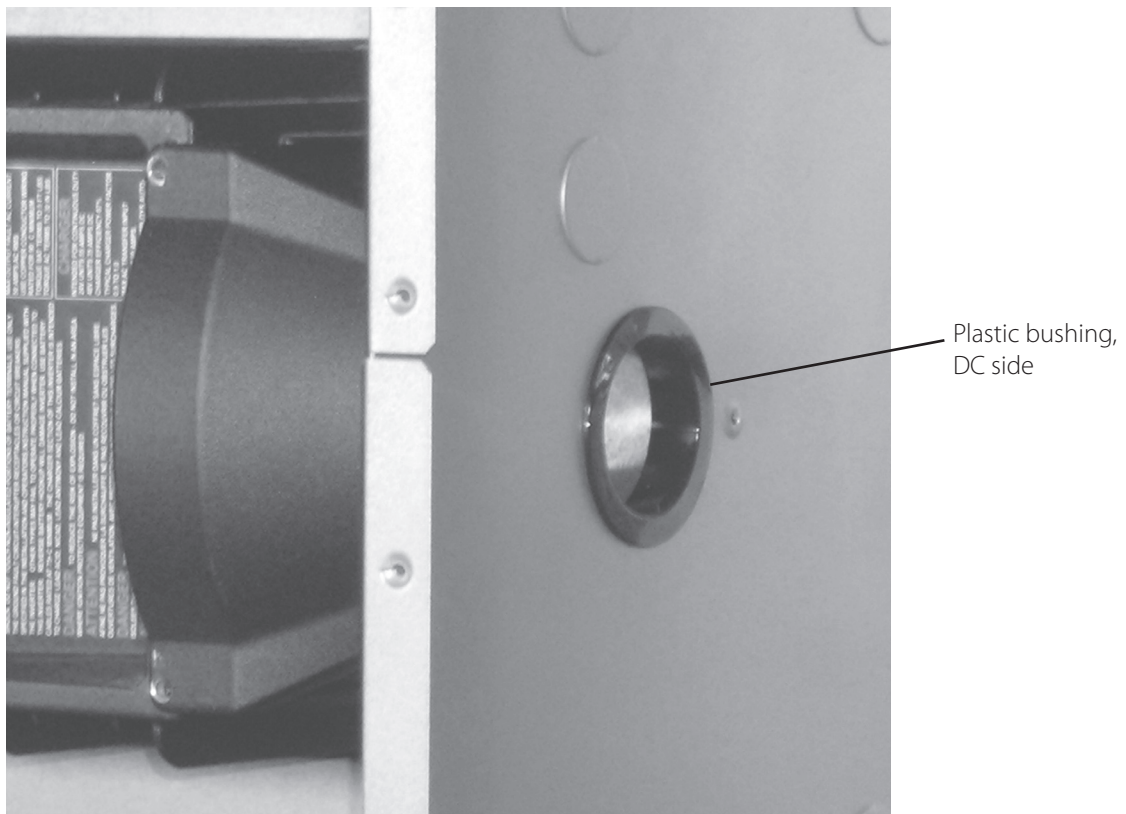

Figure 11: DCA bushing

Note: The DCA will be held firmly in place when the DCC (FX cover) is secured at the end of the installation.

To install an ACA:

- Follow the separate ACA instructions for mounting to the FX.
- Line the ACA up with the conduit hole in the AC Chassis.
- When aligned, move the AC chassis snug against the ACAs after the ACA installations.
- Press a 1" plastic bushing from inside the AC chassis out to the ACA through each previously removed knockout, sliding the AC chassis against the ACAs until snug.
- With all the ACA's aligned with the AC chassis and the bushings installed, tighten the AC chassis screws against the FW-MP.

With both the AC chassis and DC chassis installed, the breaker brackets, AC din rail(s), and optional AC and DC breakers can be installed. Please see the individual Input/Output/Bypass Breaker (IOB) kit for instructions.

MX60 Installation

A FLEXware 1000 System installation includes up to four MX Charge Controllers which can be mounted on both the top and side of the FW1000-DC. Newer MXs have rear knockouts allowing them to be mounted directly to the side of the enclosure without the need for additional mounting brackets. Mounting brackets are required for top installation of all MX models and for side installation of less recent models..

Bracket screw locations are shown below

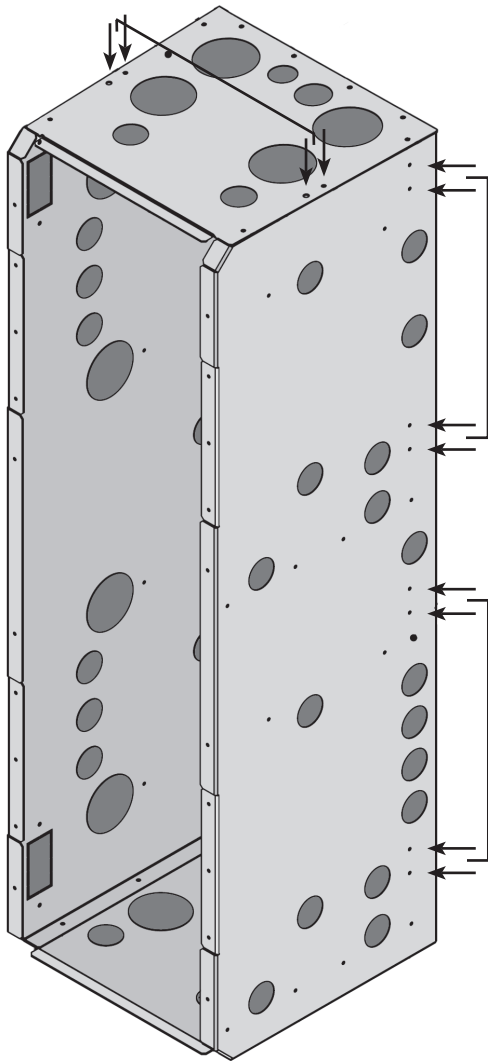

Screw locations for directly attaching an MX Charge Controller are shown below

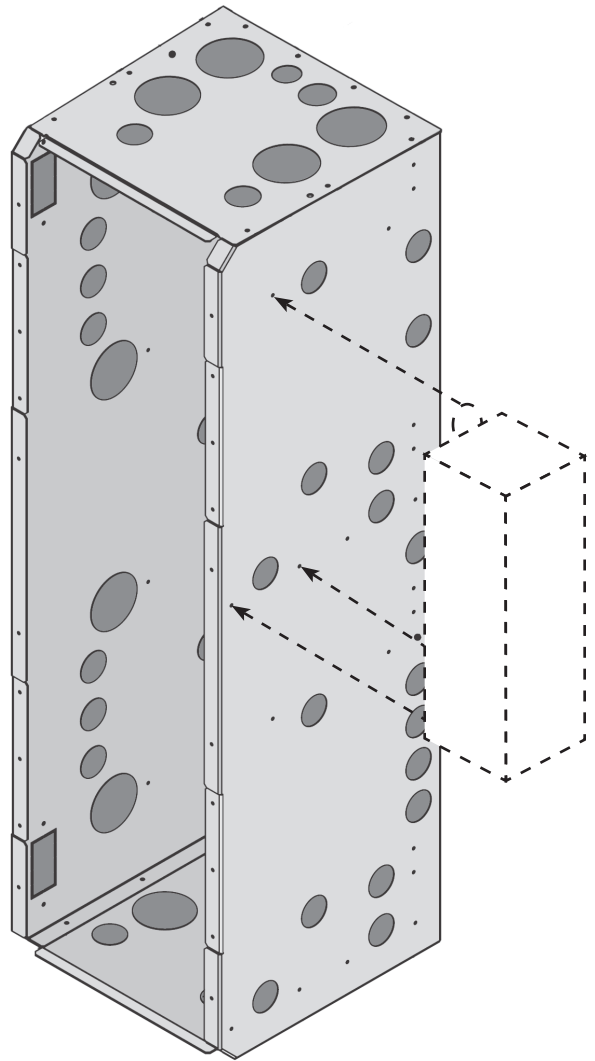

Figure 12:
MX Charge Controller mounting options

MX Knockouts

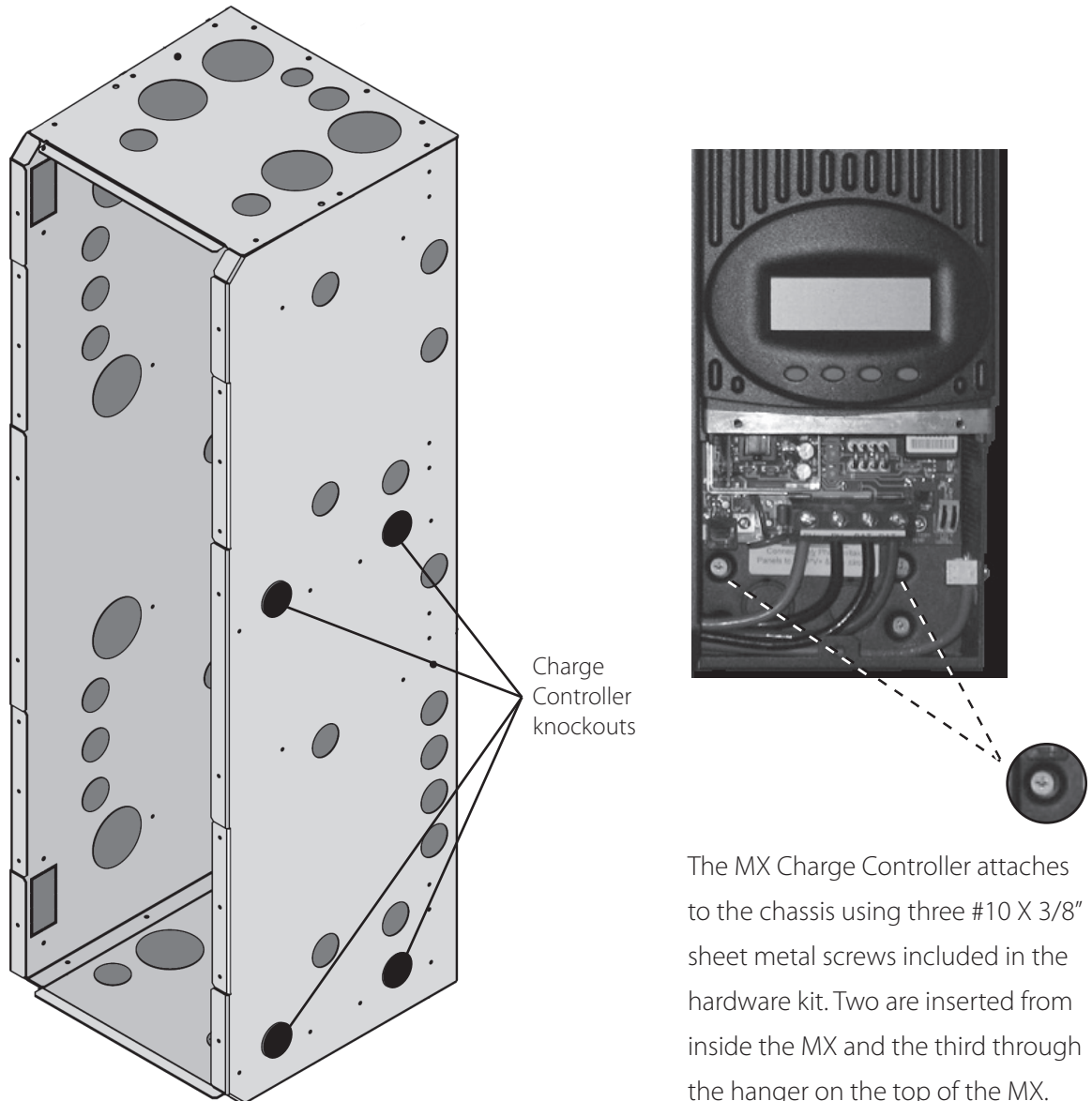

Figure 13:
MX Charge Controller 1" knockouts

The MX Charge Controller attaches to the chassis using three #10 X 3/8" sheet metal screws included in the hardware kit. Two are inserted from inside the MX and the third through the hanger on the top of the MX.

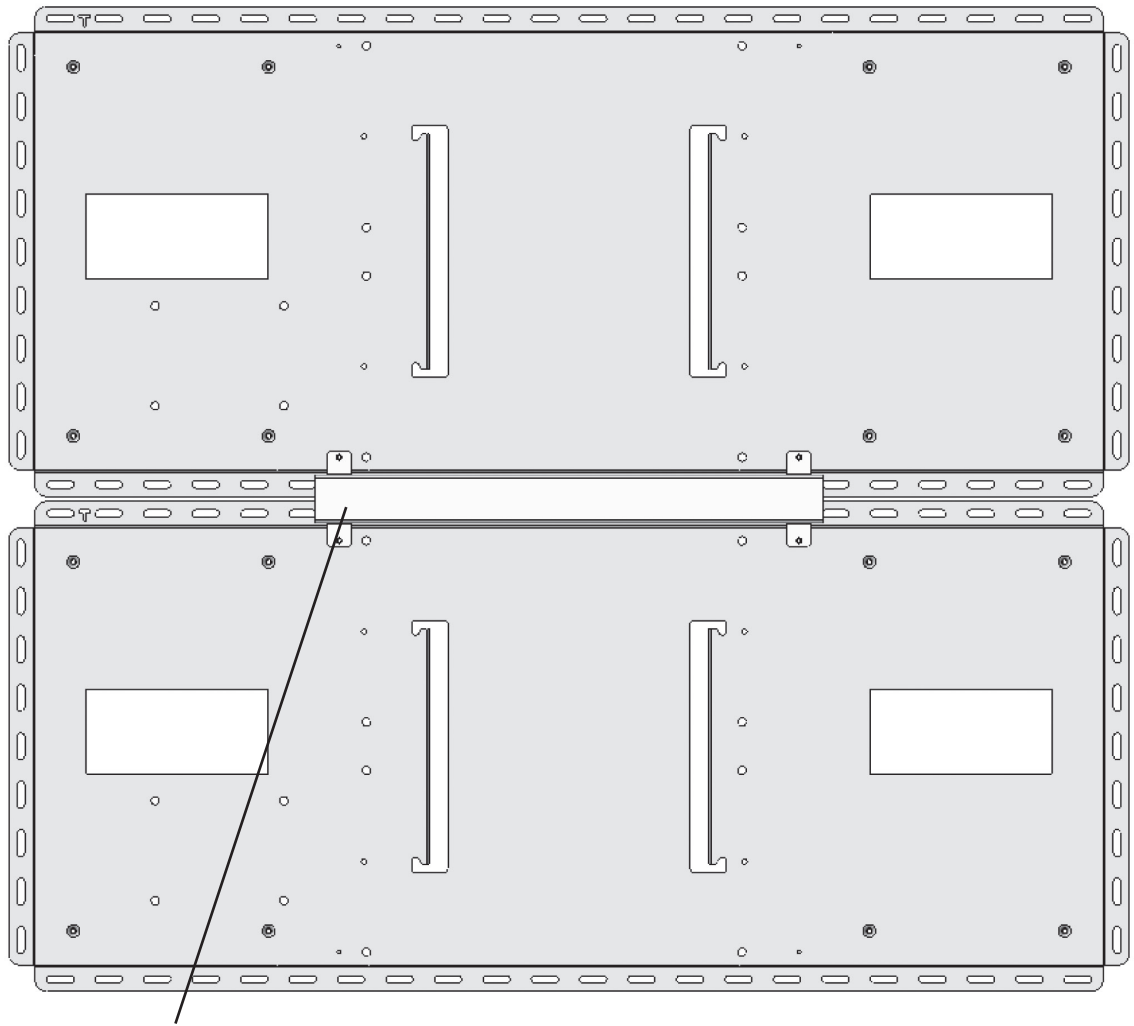

Figure 14: FLEXware Wiring Raceway

When all component and cabling installations are complete, install the FLEXware Wiring Raceway to cover and protect the exposed communication cables running between the AC and DC sides of the system. The illustration above shows FLEXware Mounting Plates with components removed for clarity.

Installing an OutBack HUB

An OutBack HUB allows the FX Series Inverter/Chargers, MX60 Charge Controllers, and MATE to communicate with each other. It attaches (see arrows in Figure 14) to the outside of the FW1000-AC (hardware included with the HUB).

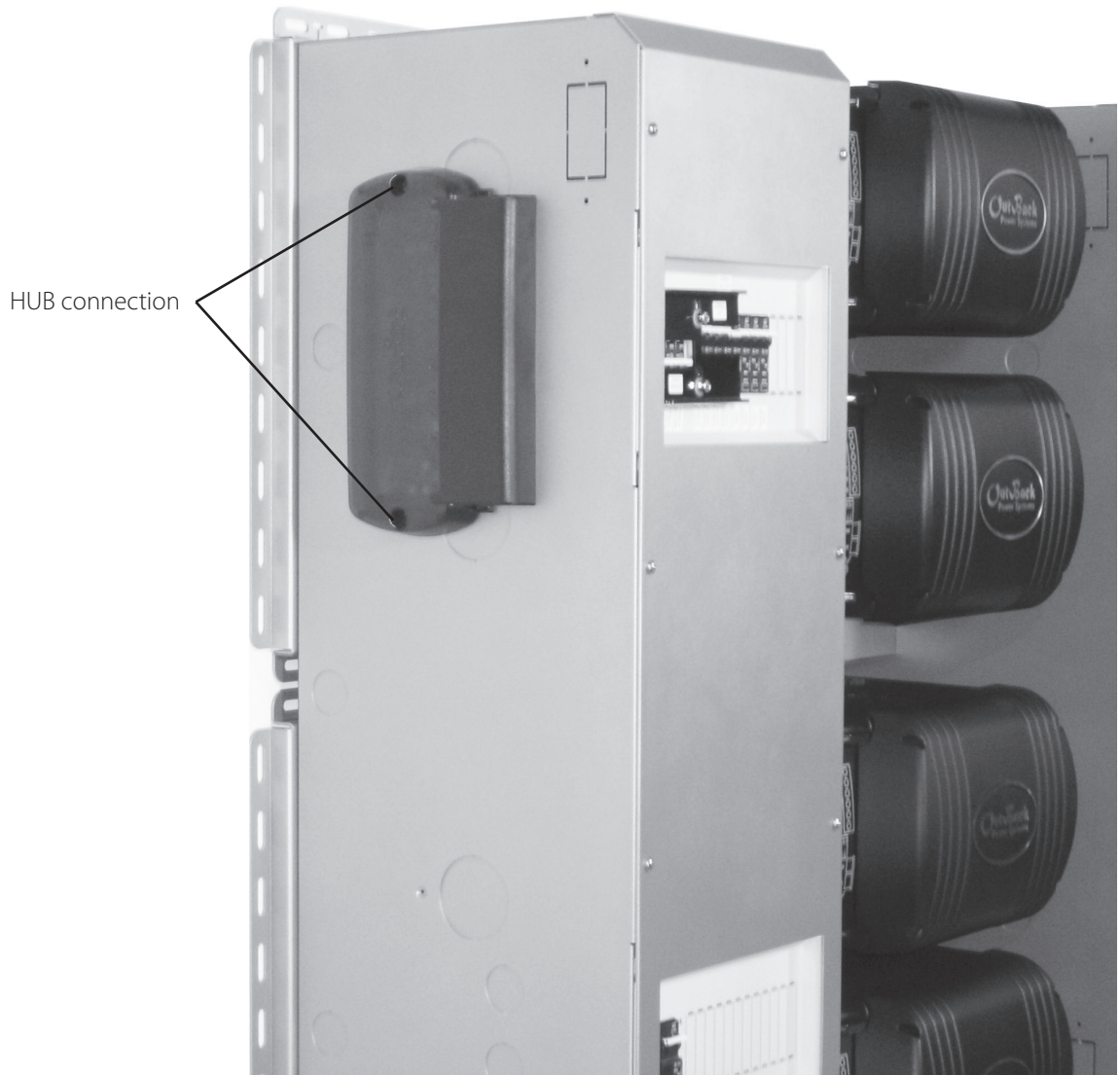

Figure 14: OutBack HUB

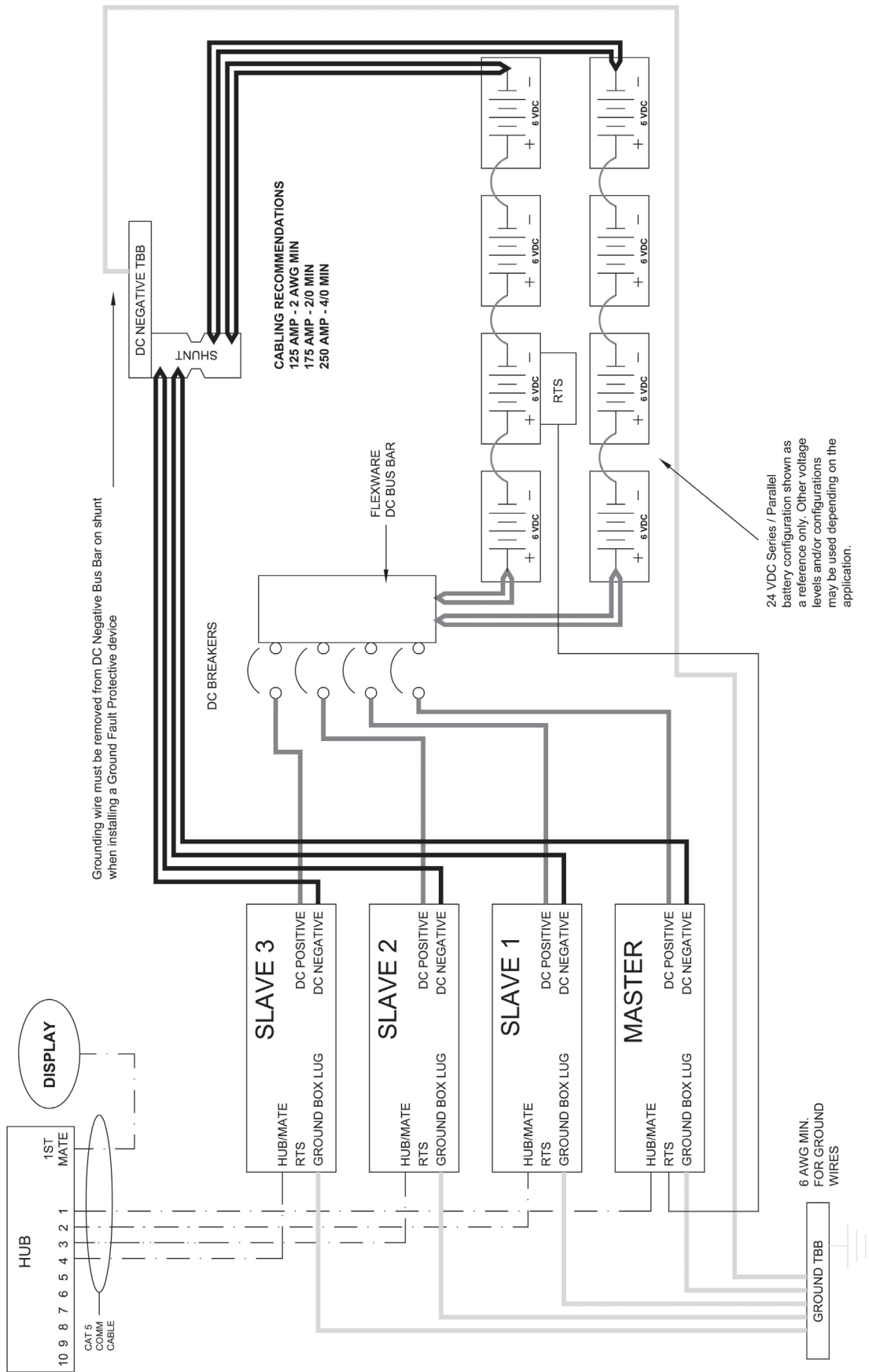

Figure 15: Wiring Diagram

Product Registration

Please take a moment to register and provide us with some important information. Send to:
OutBack Power Systems, 19009 62nd Avenue NE, Arlington, WA 98223 USA.

Name: _____

Address: _____

City, State, Zip Code: _____

Country: _____

Telephone Number: _____

E-mail: _____

Sold by: _____

Installer: _____

Purchase Date: _____ Model Number: _____

Serial Number: _____

Check all that apply:

Off-Grid Installation Grid-Tie Installation Residential Installation Commercial Installation



19009 62nd Avenue NE
Arlington, WA USA
(+1) 360-435-6030

European Sales Office
Barcelona, España
(+34) 600-843-845

www.outbackpower.com